

# Pawnee Brave 20cc

Almost-Ready-To-Fly

**HANGAR 9**

Instruction Manual  
Bedienungsanleitung  
Manuel d'utilisation  
Manuale di Istruzioni



**ARF**



Scan the QR code and select the Manuals and Support quick links from the product page for the most up-to-date manual information.

Scannen Sie den QR-Code und wählen Sie auf der Produktseite die Quicklinks Handbücher und Unterstützung, um die aktuellsten Informationen zu Handbücher. Scannez le code QR et sélectionnez les liens rapides Manuals and Support sur la page du produit pour obtenir les informations les plus récentes sur le manuel. Scannerizzare il codice QR e selezionare i Link veloci Manuali e Supporto dalla pagina del prodotto per le informazioni manuali più aggiornate.

HAN7035

Created 06/2022

**HORIZON**  
H O B B Y

## NOTICE

All instructions, warranties and other collateral documents are subject to change at the sole discretion of Horizon Hobby, LLC. For up-to-date product literature, visit horizonhobby.com or www.towerhobbies.com and click on the support or resources tab for this product.

## MEANING OF SPECIAL LANGUAGE

The following terms are used throughout the product literature to indicate various levels of potential harm when operating this product:

**WARNING:** Procedures, which if not properly followed, create the probability of property damage, collateral damage, and serious injury OR create a high probability of superficial injury.

**CAUTION:** Procedures, which if not properly followed, create the probability of physical property damage AND a possibility of serious injury.

**NOTICE:** Procedures, which if not properly followed, create a possibility of physical property damage AND a little or no possibility of injury.



**WARNING:** Read the ENTIRE instruction manual to become familiar with the features of the product before operating. Failure to operate the product correctly can result in damage to the product, personal property and cause serious injury.

This is a sophisticated hobby product. It must be operated with caution and common sense and requires some basic mechanical ability. Failure to operate this Product in a safe and responsible manner could result in injury or damage to the product or other property. This product is not intended for use by children without direct adult supervision. Do not attempt disassembly, use with incompatible components or augment product in any way without the approval of Horizon Hobby, LLC. This manual contains instructions for safety, operation and maintenance. It is essential to read and follow all the instructions and warnings in the manual, prior to assembly, setup or use, in order to operate correctly and avoid damage or serious injury.

**Age Recommendation: Not For Children Under 14 Years. This Is Not A Toy.**

## SAFETY WARNINGS AND PRECAUTIONS

Read and follow all instructions and safety precautions before use. Improper use can result in fire, serious injury and damage to property.

### Components

Use only with compatible components. Should any compatibility questions exist, please refer to the product instructions, component instructions or contact the appropriate Horizon Hobby office.

### Flight

Fly only in open areas to ensure safety. It is recommended flying be done at radio control flying fields. Consult local ordinances before choosing a flying location.

### Propeller

Always keep loose items that can become entangled in the propeller away from the prop. This includes loose clothing or other objects such as pencils and screwdrivers. Keep your hands away from the propeller as injury can occur.

### Batteries

Always follow the manufacturer's instructions when using and disposing of any batteries. Mishandling of Li-Po batteries can result in fire causing serious injury and damage.

### Small Parts

This kit includes small parts and should not be left unattended near children as choking and serious injury could result.

## SAFE OPERATING RECOMMENDATIONS

- Inspect your model before every flight to ensure it is airworthy.
- Be aware of any other radio frequency user who may present an interference problem.
- Always be courteous and respectful of other users in your selected flight area.
- Choose an area clear of obstacles and large enough to safely accommodate your flying activity.
- Make sure this area is clear of friends and spectators prior to launching your aircraft.
- Be aware of other activities in the vicinity of your flight path that could cause potential conflict.
- Carefully plan your flight path prior to launch.
- Abide by any and all established AMA National Model Aircraft Safety Code.

## BEFORE STARTING ASSEMBLY

- Remove parts from bag.
- Inspect fuselage, wing panels, rudder and stabilizer for damage.
- If you find damaged or missing parts, contact your place of purchase.
- Charge transmitter and receiver batteries.
- Center trims and sticks on your transmitter.
- For a computer radio, create a model memory for this particular model.
- Bind your transmitter and receiver, using your radio system's instructions.

**NOTICE:** Rebind the radio system once all control throws are set. This will keep the servos from moving to their endpoints until the transmitter and receiver connect. It will also guarantee the servo reversal settings are saved in the radio system.

## IMPORTANT FEDERAL AVIATION ADMINISTRATION (FAA) INFORMATION



Use the QR code to learn more about the **Recreational UAS Safety Test (TRUST)**, as was introduced by the 2018 FAA Reauthorization Bill. This free test is required by the FAA for all recreational flyers in the United States. The completed certificate must be presented upon request by any FAA or law enforcement official.



If your model aircraft weighs more than .55lbs or 250 grams, you are required by the FAA to register as a recreational flyer and apply your registration number to the outside of your aircraft. Use the QR code to learn more about registering with the FAA..

## TABLE OF CONTENTS

|   |    |
|---|----|
| Notice.....   | 2  |
| Meaning of Special Language.....                                      | 2  |
| Safety Warnings and Precautions.....                                  | 2  |
| Safe Operating Recommendations.....                                   | 2  |
| Before Starting Assembly.....   | 2  |
| Important Federal Aviation Administration (FAA) Information.....      | 2  |
| Replacement Parts.....  | 3  |
| Optional Parts.....   | 3  |
| Required for Completion, All Power Options.....                       | 4  |
| Required for Completion, Gas Engine Installation.....                 | 4  |
| Required for Completion, Electric Motor Installation.....             | 4  |
| Required Adhesives.....   | 4  |
| Tools Required.....   | 4  |
| Removing Wrinkles.....  | 5  |
| Building Precautions.....   | 5  |
| Transportation and Storage.....                                       | 5  |
| Replacement Covering.....   | 5  |
| Checking Blind Nuts.....  | 5  |
| Aileron Control Horn Installation.....                                | 5  |
| Aileron and Flap Hinging.....   | 6  |
| Aileron Servo Installation.....                                       | 7  |
| Flap Servo Installation.....  | 9  |
| Landing Light Installation.....                                       | 10 |
| Hinging the Elevators.....  | 10 |
| Stabilizer Installation.....  | 11 |
| Vertical Stabilizer Installation.....                                 | 12 |
| Rudder Installation.....  | 13 |
| Tailwheel Installation.....   | 13 |
| Elevator Servo Installation.....                                      | 14 |
| Rudder Servo Installation.....  | 15 |
| Receiver and Receiver Battery Installation.....                       | 15 |
| Landing Gear Installation.....  | 16 |
| Electric Motor Installation.....                                      | 16 |
| Gas Engine Installation.....  | 18 |
| Fuel Tank Installation.....   | 21 |
| Cowling Installation.....   | 22 |
| Canopy Hatch assembly.....  | 23 |
| Center of Gravity.....  | 24 |
| Control Throws.....   | 25 |
| Preflight Checklist.....  | 25 |
| Daily Flight Checks.....  | 25 |
| Limited Warranty.....   | 25 |
| Warranty and Service Contact Information.....                         | 26 |
| WEEE NOTICE.....  | 26 |
| Academy of Model Aeronautics National Model Aircraft Safety Code..... | 27 |
| Building Notes.....   | 27 |

## REPLACEMENT PARTS

| Item #    | Description             |
|-----------|-------------------------|
| HAN703501 | Fuselage                |
| HAN703502 | Wing; Left-Hand         |
| HAN703503 | Wing; Right-Hand        |
| HAN703504 | Stabilizer and Elevator |
| HAN703505 | Fin and Rudder          |
| HAN703506 | Cowling                 |
| HAN703507 | Fuselage Hatch          |
| HAN703508 | Canopy                  |
| HAN703509 | Landing Gear            |
| HAN703510 | Wing Tube               |
| HAN703511 | Hardware Set            |
| HAN703512 | Pushrod Set             |
| HAN703513 | Tailwheel Assembly      |
| HAN703514 | Spinner                 |
| HAN703515 | Decal Sheet             |
| HAN703516 | EP Mount Box            |
| HAN703517 | Fuel Tank               |
| HAN703518 | Wheels                  |
| HAN703519 | LED Light Set           |
| HAN703520 | Pilot Figure            |

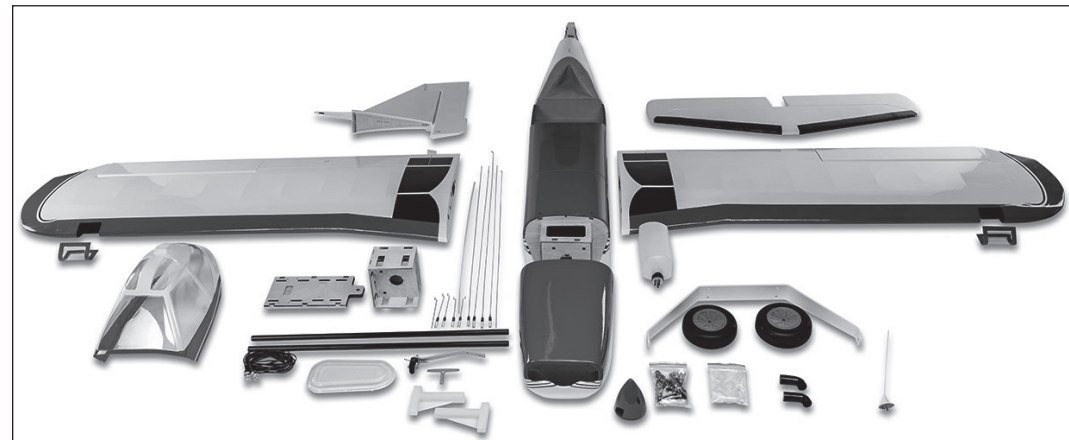

## OPTIONAL PARTS

| # Required | Item #    | Description                      |
|------------|-----------|----------------------------------|
| 1          | SPMA100   | Optical Ignition Kill Switch     |
| 1          | SPMXCA514 | Extension:IC5 Battery/IC5 Device |
| 1          | SPMA3054  | Servo Connector Clips (25)       |

## REQUIRED FOR COMPLETION, ALL POWER OPTIONS

| # Required | Item #       | Description                                 |
|------------|--------------|---|
| 2          | SPMA3004     | Heavy-Duty Servo Extension 18-inch          |
| 1          | SPMAR8360T   | AR8360T 8CH SAFE Telemetry RX               |
| 3          | SPMA3000     | Heavy-Duty Servo Extension 3-inch           |
| 5          | SPMA3001     | Heavy-Duty Servo Extension 6-inch           |
| 1          | SPMA3003     | Heavy-Duty Servo Extension 12-inch          |
| 6          | SPMSAG380    | A6380 H-T/H-S Digital HV Servo              |
| 2          | SPMX20002SRX | 2000mAh 2S 7.4V Smart Receiver Battery; IC3 |

## REQUIRED FOR COMPLETION, GAS ENGINE INSTALLATION

| # Required | Item #    | Description  |
|------------|-----------|--|
| 1          | APC17060  | Competition Propeller, 17 x 6                      |
| 1          | DLEG0420  | DLE-20RA Gas Rear Exhaust with Electronic Ignition |
| 2          | SPM9530   | Spektrum 3-Wire Switch Harness                     |
| 1          | SUL211    | 2' ProFlex Universal Fuel Line                     |
| 1          | SPMSAG380 | A6380 H-T/H-S Digital HV Servo                     |

## REQUIRED FOR COMPLETION, ELECTRIC MOTOR INSTALLATION

| # Required | Item #     | Description                           |
|------------|------------|---------------------------------------|
| 1          | APC17070E  | Electric Propeller, 17 X 7E           |
| 1          | SPMX56S50  | 5000mAh 6S 22.2V Smart G2 50C;        |
| 1          | SPMXAE1100 | Avian 100 Amp Brushless Smart ESC, 6S |
| 1          | SPMXAM4770 | 5065-450Kv Outrunner BL Mot           |

## REQUIRED ADHESIVES

| Description                        |
|------------------------------------|
| 15-minute epoxy                    |
| 30-minute epoxy                    |
| Thin CA                            |
| Medium CA                          |
| Thread lock, low and high strength |

## TOOLS REQUIRED

| Description                                       |
|---|
| Box or open end wrench: 10mm, 7/16-inch, 1/2-inch |
| Clamps  |
| Covering iron                                     |
| Cutoff wheel for rotary tool                      |
| Drill   |
| Drill bit set, metric and english                 |
| Epoxy brushes                                     |
| Felt-tipped pen                                   |
| Flat blade screwdriver                            |
| Flat file   |
| Flux paste  |
| Heat gun  |
| Hemostats   |
| Hex wrench set, metric and english                |
| Hobby knife with #11 blade                        |
| Hobby scissors                                    |
| Hobby square                                      |
| Hook and loop tape                                |
| Light machine oil                                 |
| Low tack tape                                     |
| Medium grit sandpaper                             |
| Mixing cups                                       |
| Mixing sticks                                     |
| Pencil  |
| Phillips screwdriver #1, #2                       |
| Pin vise  |
| Pliers  |
| Razor saw   |
| Rotary tool                                       |
| Ruler   |
| Sanding drum for rotary tool                      |
| Scissors  |
| Side cutter                                       |
| Silver solder                                     |
| Stepped reamer                                    |
| Toothpicks  |
| Torch or soldering iron                           |
| Vise grips  |
| Wire cutter                                       |



## REMOVING WRINKLES

The covering of your model may develop wrinkles during shipping. Use a covering iron with a sealing iron sock (HAN141) to remove them. Start with a lower heat setting and use caution while working around areas where the colors overlap to prevent separating the colors. It is also advised to use caution around the canopy as it is plastic and could distort with excessive heat. Avoid using too much heat, which could also separate the colors. Placing a cool damp cloth on adjacent colors will also help prevent the separation of the colors while removing wrinkles. Only use a heat gun (HAN100) once the covering iron has been used.

## BUILDING PRECAUTIONS

Prepare the work surface prior to beginning the build. The surface should be soft and free of any sharp objects. We recommend resting the airframe parts on a soft towel or pit mat to prevent scratching or denting the surface of the aircraft.

## TRANSPORTATION AND STORAGE

When transporting and storing your model, you will need a minimum of 80 inches (2.1m) in length, and 19 inches (50cm) in height to accommodate the size of the fuselage. We also recommend the use of wing and stabilizer bags to help protect these surfaces during transport and storage. The control horns and linkages can cause damage to other surfaces even when placed in storage bags. Always transport and store the wings and stabilizer so the linkages do not contact other panels to prevent damage.

## REPLACEMENT COVERING

Your model is covered with UltraCote® film in the following colors. If repairs are required, order these coverings to make those repairs.

White HANU870

Black HANU874

True Red HANU866

## CHECKING BLIND NUTS

When building the aircraft, you will be required to thread machine screws into blind nuts. We recommend pre-threading the screws to make sure the blind nuts are clear of any debris. If the screws do not thread in easily, clear the threads using the appropriate tap and tap handle.

## AILERON CONTROL HORN INSTALLATION

1. Use a felt-tipped pen to mark the center of the slot in the hinges on both the wing and control surfaces.
2. Separate the aileron and flap from the wing. Set the hinges aside.
3. Use a rotary tool and 1/16-inch (1.5mm) drill bit to drill the location in the wing trailing edge and control surfaces marked in Step 1.
4. Use medium-grit sandpaper to lightly sand the control horns where they fit into the control surface. Clean the sanded area using a paper towel and isopropyl alcohol to remove any debris or oils.  
→ Use tape on the painted area to help prevent removing the paint from the exposed portion of the control horn. Remove the tape once the control horn has been sanded.
5. Locate the control horns marked "A" for the ailerons. Test fit the control horns in the slots for the ailerons. Do not force the control horn into the slot.

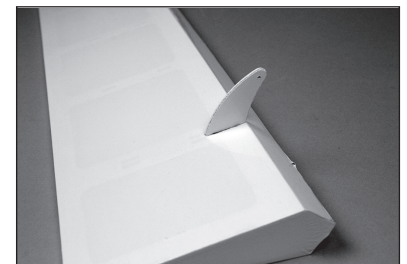
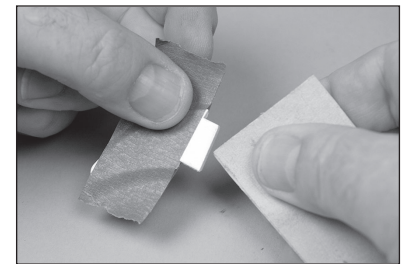
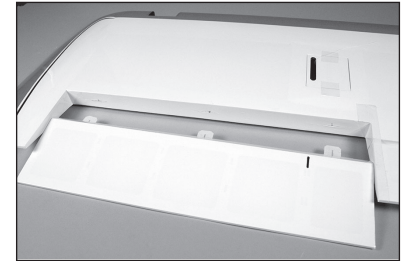

6. Use low-tack tape around the control horns to prevent epoxy from getting on the control surface.

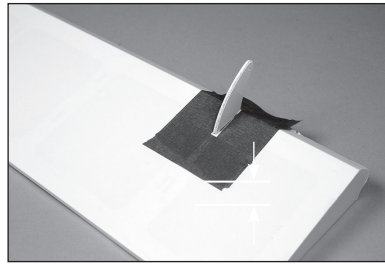

7. Use a square to check that the control horn is square to the control surface. The slot in the control surface can be carefully adjusted using a hobby knife.

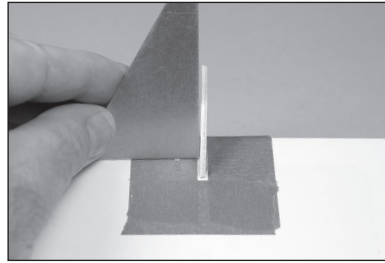

8. Apply epoxy to the slot in the control surface. Make sure the epoxy gets into the slot for a good bond between the surfaces and control horn.

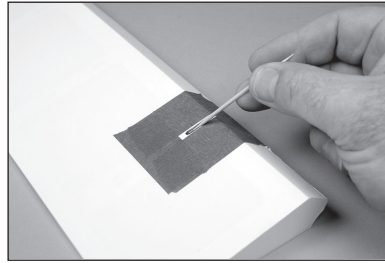

9. Apply epoxy to the area of the control horn that fits into the slot. Apply epoxy to all the surfaces of the control horn that fit into the control surface.

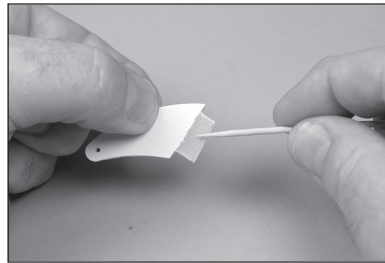

10. Use a paper towel and isopropyl alcohol to remove any excess epoxy.

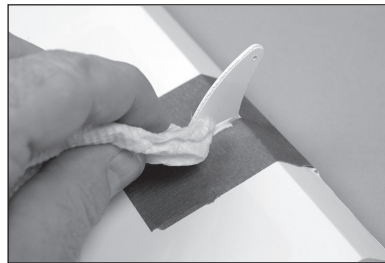

11. Before the epoxy fully cures, remove the tape from around the control horn. This will allow the epoxy to flow around the control horn, creating a small fillet between the control horn and surface for a finished look and secure bond. Allow the epoxy to fully cure before proceeding.

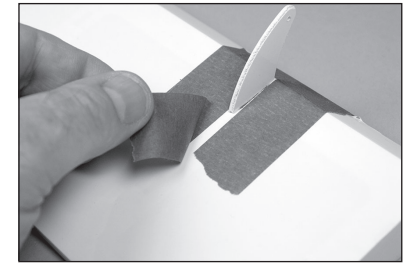

- Use the control horns marked "F" and repeat the previous section to install the flap control horns.

## **AILERON AND FLAP HINGING**

12. Place a T-pin in the center of each hinge. This will keep the hinges centered when they are installed.

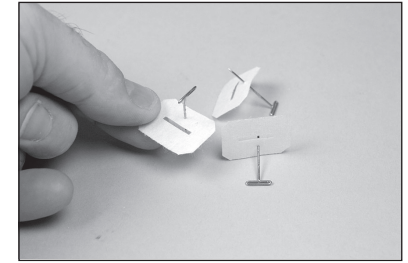

13. Fit the hinge in the hinge slot. Align the slot in the hinge with the hole in the wing. Install the hinges for the aileron and flap.

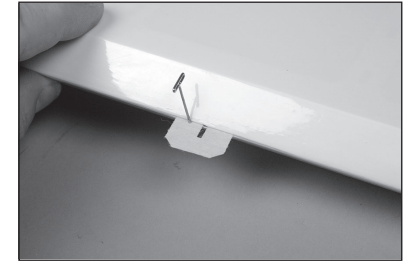

14. Fit the aileron into position on the hinges.

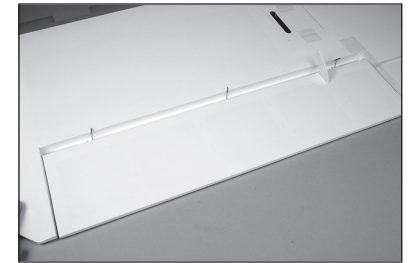

15. Fit the flap into position on the hinges.

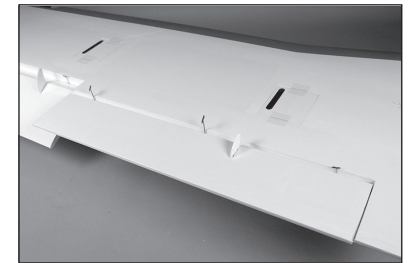

16. Remove the T-pins from the hinges.

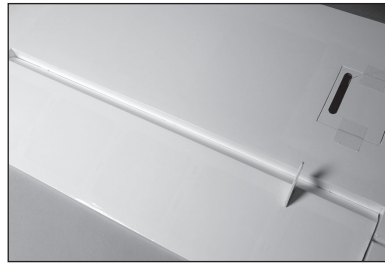

17. Check the gap between the aileron at the wing tip.



18. Check the gap between the aileron and flap.

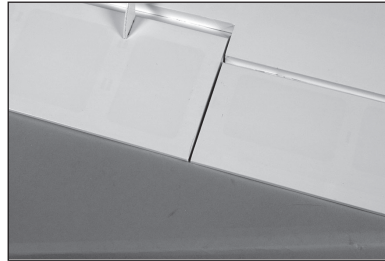

19. Finally, check the gap between the wing and flap at the wing root. Adjust the position of the aileron and flap so all three gaps are equal.

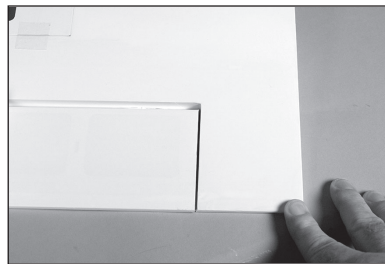

20. Soak thin CA into each of the hinges, both on the top and bottom of the hinge.

→ Do not use accelerator on the hinges. The CA must be allowed to wick into the hinge to provide the best bond between the hinge and surrounding wood.



21. Once the CA has fully cured, gently pull on the wing and aileron to make sure the hinges are secure.

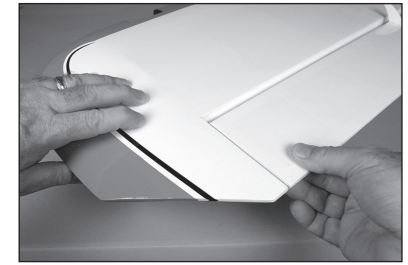

22. Break in the hinges by flexing the control surface through its range of motion in both directions.



## AILERON SERVO INSTALLATION

23. Remove the servo cover for the aileron.

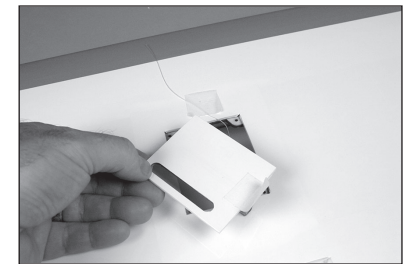

24. Use a toothpick or hobby knife with a #11 blade to puncture the aileron servo cover for the mounting screws.

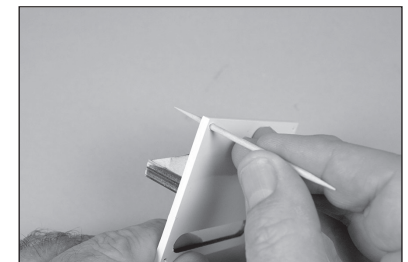



25. Use a #1 Phillips screwdriver to thread an M2.5 x 10 self-tapping screw into each of the holes. Remove the screws before proceeding.

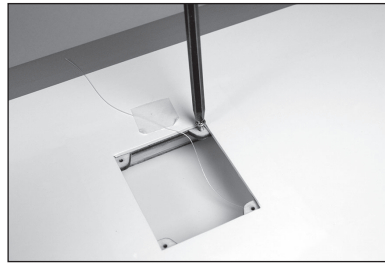

26. Apply 1–2 drops of thin CA in each hole to harden the surrounding wood. Allow the CA to fully cure before proceeding.



27. Use a pin vise or drill and 5/64-inch (2mm) drill bit to drill through the holes in the servo mount.

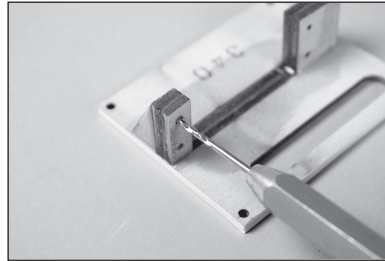

28. Thread a servo mounting screw into each hole, then remove all the screws. Apply 1–2 drops of thin CA in each hole to harden the surrounding wood. Allow the CA to fully cure before proceeding. Mount the servo using the screws provided with the servo. Note the orientation of the servo on the servo cover

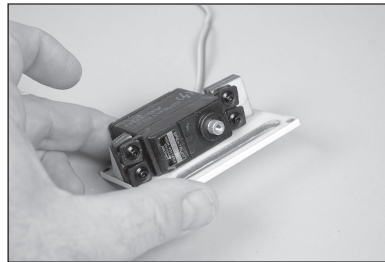

29. Secure a 9-inch (225mm) servo extension to the servo lead using a commercially available retainer (Servo Connector Clips, SPMA3054).

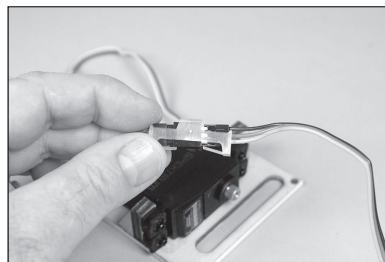

30. Center the servo using the radio system. Place the control horn on the servo so it is perpendicular to the servo. Remove any arms from the servo horn that will interfere with the operation of the servo.

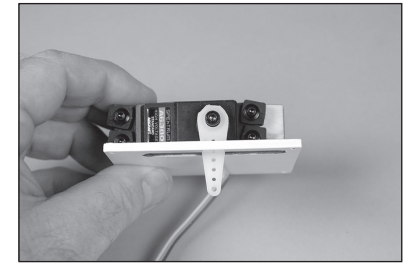

31. When attaching the linkage to the servo arm, use the hole that is 1 in (25mm) from the center of the servo horn. This hole will need to be enlarged using a pin vise and 5/64-inch (2mm) drill bit.

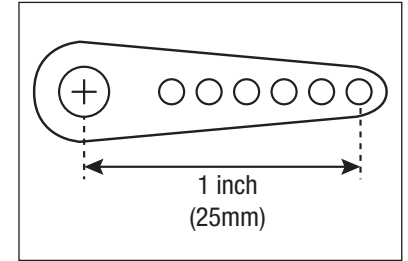

32. Tie or tape the string located inside the wing to the end of the servo lead.

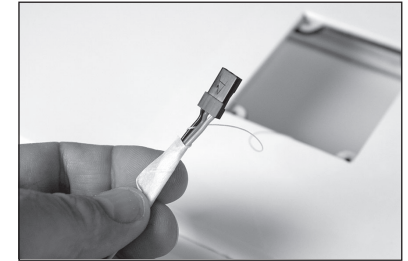

33. Guide the servo lead for the aileron through the wing to the wing root.

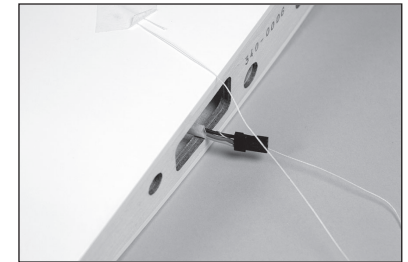

34. Secure the aileron servo cover using a #1 Phillips screwdriver and four M2.5 x 10 self-tapping screws.





35. Locate the linkage for the ailerons. With the clevis removed, the linkage will measure  $3\frac{5}{32}$  inches (80mm).

→ The clevis does not require removal. This step is for reference only.

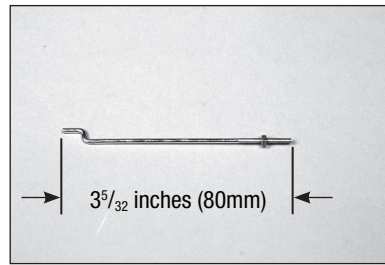

36. Insert the bend in the linkage through the hole in the servo arm indicated in Step 34.

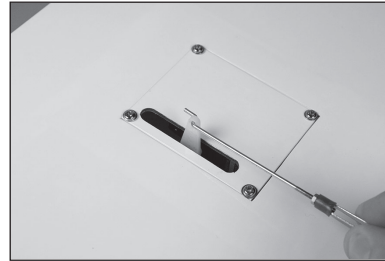
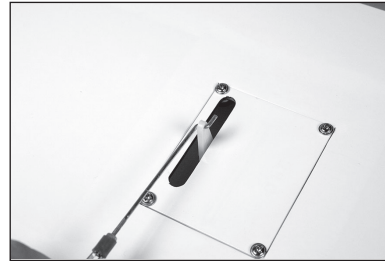

37. With the servo connected to the radio system, center the servo using the radio system. Connect the clevis to the control horn.

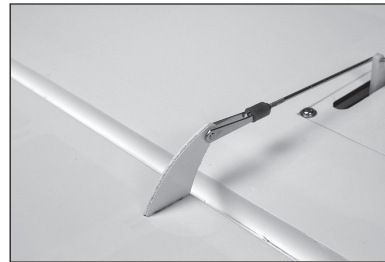

38. Adjust the linkage so the aileron aligns with the wing tip.

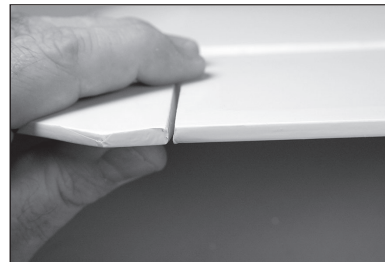

39. Once aligned, slide the silicone retainer over the forks of the clevis. Thread the nut away from the clevis. Apply a small drop of threadlock on the threads near the clevis. Use pliers to tighten the nut against the clevis.

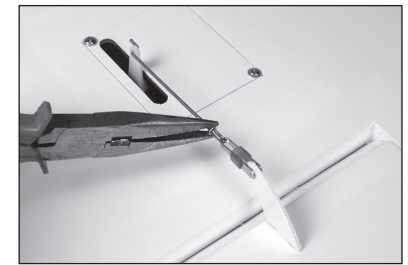

## FLAP SERVO INSTALLATION

40. Repeat the steps for installing the aileron servo to the servo cover to install the flap servo.

→ Set the flap travel to 0%, then attach the servo arm 90-degrees to the servo center line.

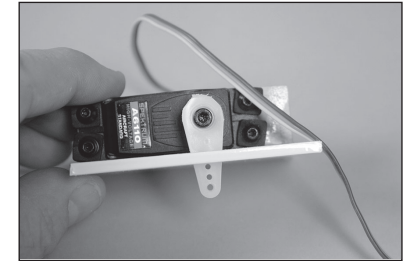

41. When attaching the linkage to the servo arm, use the hole that is  $13/16$  in (21mm) from the center of the servo horn. This hole will need to be enlarged using a pin vise and  $5/64$ -inch (2mm) drill bit.

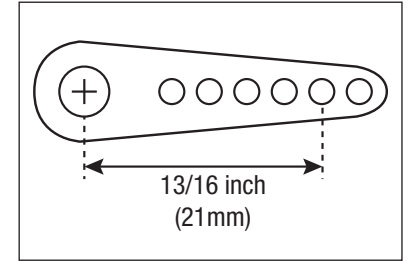

42. Locate the linkage for the flaps. With the clevis removed, the linkage will measure  $3\frac{1}{2}$  inches (90mm).

→ The clevis does not require removal. This step is for reference only.

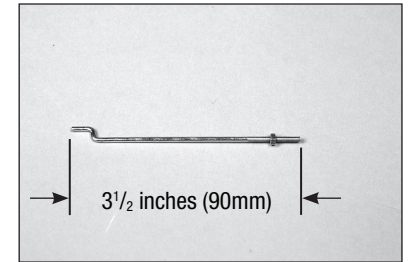

43. Install the servo in the wing and secure the servo cover using M2.5 x 10 self-tapping screws. Make sure to prepare and harden the threads in the wood as outlined for the aileron servo covers. Attach the linkage to the servo and control horn.

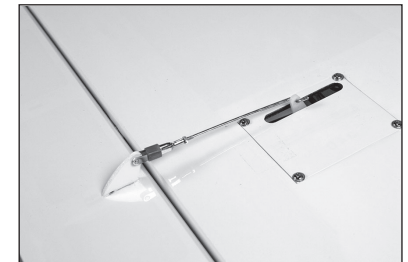

44. With the flap servo centered using the radio system, adjust the linkage to achieve the 1 inch (25mm) mid-flap throw.



45. Move the control at the transmitter to the raised flap position. Adjust the throw percentage of throw at the radio to align the flap with the trailing edge of the wing at the root.

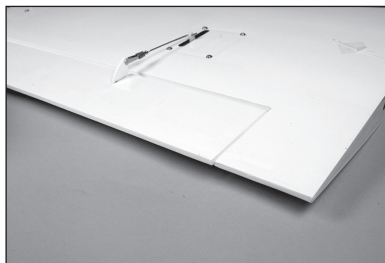

46. Move the control at the transmitter to the full flap position. Adjust the throw percentage of throw to achieve the 2<sup>11</sup>/<sub>32</sub> inches (60mm) full-flap throw.

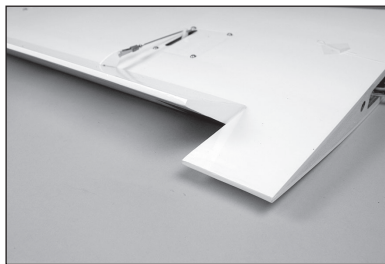

## LANDING LIGHT INSTALLATION

- The landing lights can be powered by a 800mAh 3S LiPo battery (not included). Connectors (not included) will need to be installed to connect them to a switch (not included) or Y-harness (not included) to operate. An 800mAh battery is adequate to operate the lights for an entire flying session.

47. Insert the wire into the wing for the landing light. You will need to use a pushrod wire or similar to retrieve the wire at the root of the wing.

- Use a hobby knife with a #11 blade or round file to carefully enlarge the hole so the landing light fits snugly.

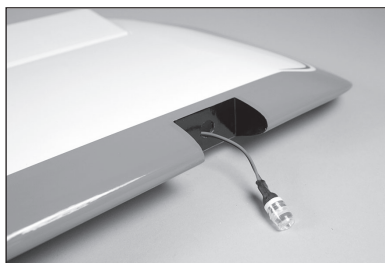

48. Use a small amount of silicone adhesive to glue the landing light into position in the wing.

- Apply a drop of thin CA to the light where the lens cover fits to secure the lens cover to the metal body of the light

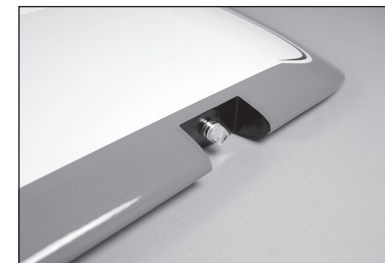

49. The landing light cover for the landing light is not symmetrical and will conform to the airfoil of the wing. Make sure it is oriented the correct direction when gluing it in place.

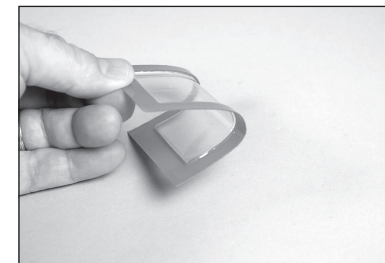

50. Use canopy glue to glue the landing light cover to the wing. Use low-tack tape to hold the cover in position until the adhesive fully cures.

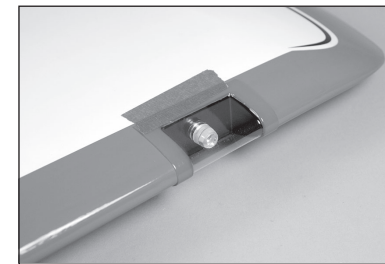

## HINGING THE ELEVATORS

51. Prepare and hinge the elevators to the stabilizer. Make sure the tips of the elevators and stabilizer are aligned before gluing the hinges. Make sure to verify the hinges are securely glued before proceeding.



52. Locate the control horns marked "E" for the elevators. Use epoxy to glue the elevator control horns in position. Allow the adhesive to fully cure before proceeding.



53. Use a small piece of low-tack tape to hold the elevators in alignment with the stabilizer for the next few steps.

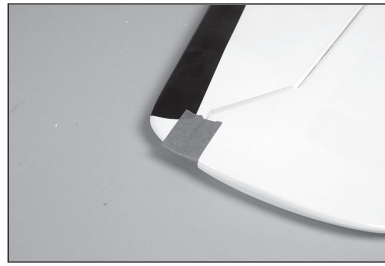

## STABILIZER INSTALLATION

54. Remove the canopy hatch from the fuselage by sliding the latch located behind the hatch rearward. Lift the hatch at the rear and remove it from the fuselage. Set it aside in a safe location.



55. Slide the wing tubes into the wing tube sockets.



56. Use a hobby knife with a #11 blade to remove the covering for the two wing bolts and the opening for the servo leads on both sides of the fuselage.



57. Slide the wing panel into position. Guide the flap and aileron leads into the fuselage.

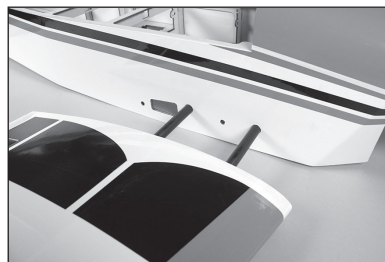

58. Secure the wing to the fuselage using two 1/4-20 x 1 nylon wing bolts.

- Only one wing bolt per wing panel (near the wing tube) is required for normal flying. Use two wing bolts when flying your model more aggressively.

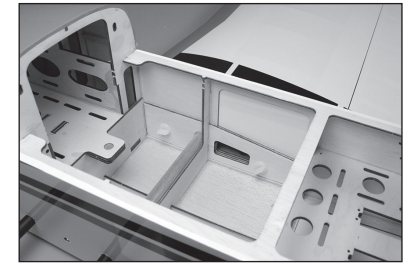

59. Repeat the steps to secure the remaining wing panel on the fuselage.

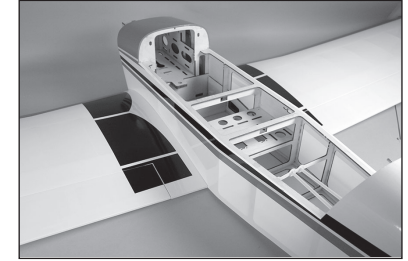

60. Place the stabilizer in position. The control horn will be on the bottom of the elevators when installed.

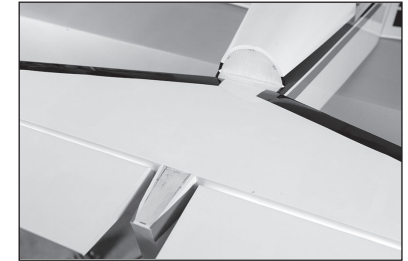

61. Stand back 8-10 feet (2-3 meters) and check that the stabilizer is aligned with the wing. Lightly sand the stabilizer saddle on the fuselage to correct any misalignment.

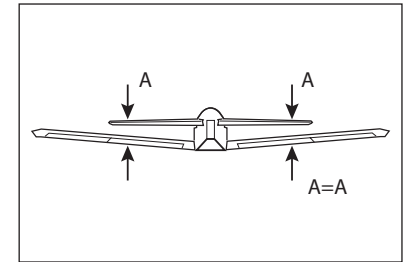

62. Measure from each wing tip to each stabilizer tip. Adjust the stabilizer so the measurements are the same for both sides.

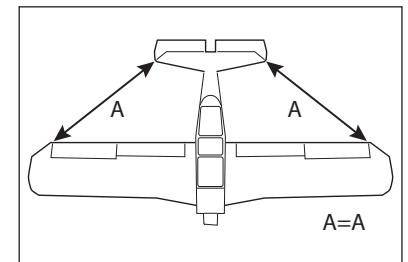



63. Use a felt-tipped pen to transfer the fuselage outline onto the bottom of the stabilizer.

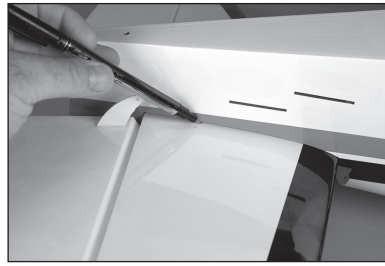

64. Use a hobby knife with a #11 blade to carefully cut the covering 1/8 inch (3 mm) inside the line drawn on the bottom of the stabilizer to remove the covering from the center of the stabilizer. Use care not to cut into the underlying wood, weakening the stabilizer.

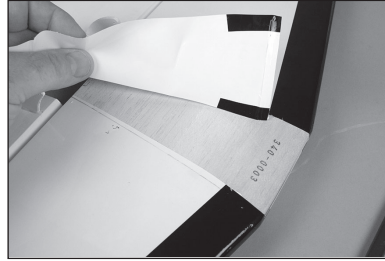

65. Use a hobby knife with a #11 blade to carefully cut the covering at the leading edge when the stabilizer comes into contact with the fuselage.

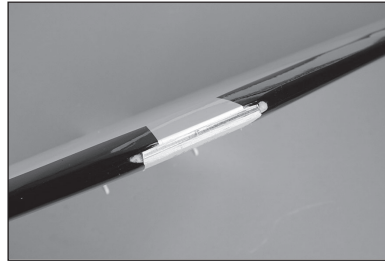

66. Use a hobby knife with a #11 blade to carefully cut the covering at the trailing edge when the stabilizer comes into contact with the fuselage.

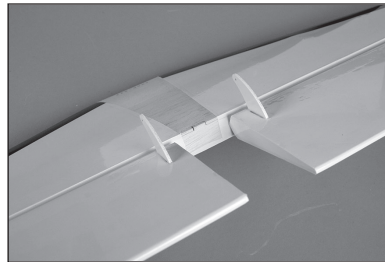

- Remove any marks from the stabilizer and fuselage using isopropyl alcohol and a paper towel.

67. Mix 3/4 ounce (25ml) of 30-minute epoxy. Use an epoxy brush to apply epoxy to the exposed wood on the bottom of the stabilizer.

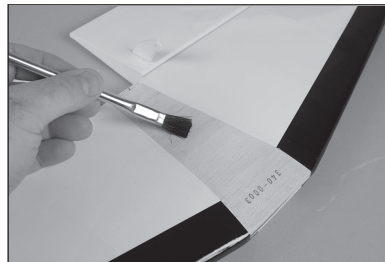

68. Use an epoxy brush to apply epoxy to the stabilizer mounting surface for the stabilizer. Position the stabilizer back on the fuselage and check its alignment. Use a paper towel and a small amount of isopropyl alcohol to remove any excess epoxy from the fuselage and stabilizer before the epoxy fully cures. Allow the epoxy to fully cure before proceeding.



- Check the position of the stabilizer repeatedly during the curing process to make sure it has not moved.

## VERTICAL STABILIZER INSTALLATION

69. Remove the rudder and hinges from the fin. Place the fin on the stabilizer and trace the outline on the top of the stabilizer using a felt-tipped pen.



70. Trace the outline on the top of the fuselage using a felt-tipped pen.

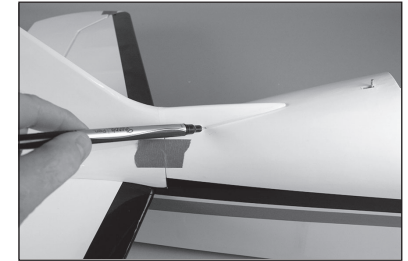

71. Use a hobby knife with a #11 blade to carefully cut the covering 1/8 inch (3 mm) inside the line drawn on the top of the stabilizer and fuselage to remove the covering. Use care not to cut into the underlying wood, weakening the stabilizer or fuselage.



72. Mix 3/4 ounce (25ml) of 30-minute epoxy. Use an epoxy brush to apply epoxy to the exposed wood on the top of the stabilizer.





73. Use an epoxy brush to apply epoxy to the fin mounting surface.

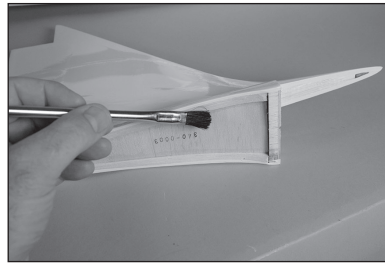

74. Position the fin back on the fuselage. Use a paper towel and a small amount of isopropyl alcohol to remove any excess epoxy from the fuselage and stabilizer before the epoxy fully cures. Use low-tack tape to hold the fin secure while the adhesive fully cures. Allow the epoxy to fully cure before proceeding.

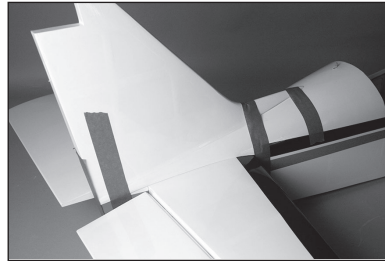

## RUDDER INSTALLATION

75. Use a hobby knife with a #11 blade to cut the slot in the fuselage for the bottom rudder hinge.

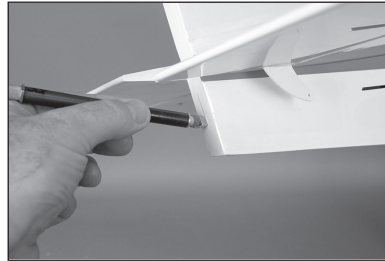

76. Locate the control horn marked "R" for the rudder. Use 5-minute epoxy to glue the rudder control horn in position. Allow the adhesive to fully cure before proceeding.

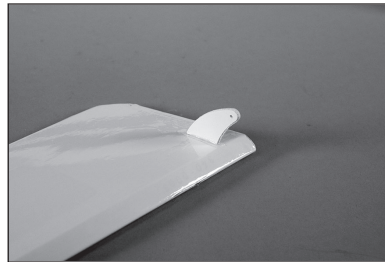

77. Hinge the rudder to the fin and fuselage using the techniques outlined previously in this manual.



## TAILWHEEL INSTALLATION

78. Place the tailwheel arm on the bottom of the rudder. Use a felt-tipped pen to mark the locations for the mounting screws on the rudder.

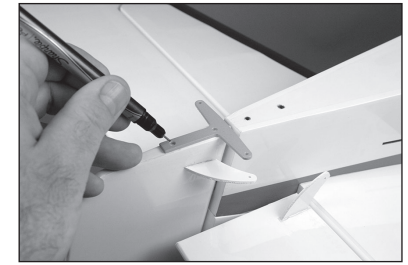

79. Use a drill and 1.5mm drill bit to drill the two holes for the tailwheel arm mounting screws.

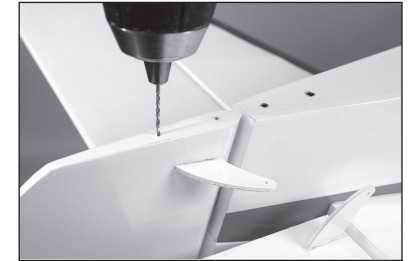

80. Thread an M2.5 x 10 sheet metal screw into each hole using a #2 Phillips screwdriver.



81. Remove the screws and apply 2-3 drops of thin CA into each hole.



82. Once the CA has fully cured, attach the tailwheel arm to the bottom of the rudder using the two screws and a #2 Phillips screwdriver.



83. Place the M3 lock washers on the M3 x 12 tailwheel bracket mounting screws.

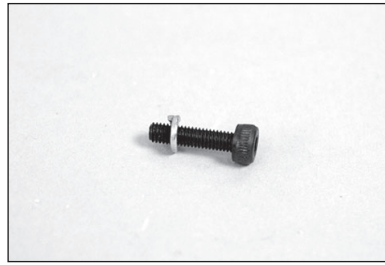

84. Attach the tail wheel bracket to the bottom of the fuselage using the two M3 x 12 socket head screws. Use a 2.5mm hex wrench to tighten the screws.



85. Bend the ends of the springs so the end can be inserted inside the coils of the spring. Make sure both springs are the same length after bending.

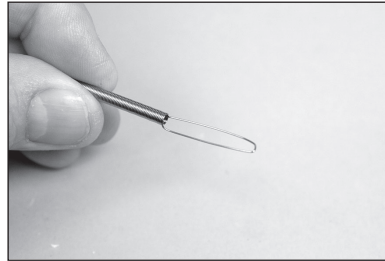

86. Connect the tailwheel steering arm to the arm on the bottom of the rudder using the two springs. Bend the loops on the ends of the springs as necessary to attach and secure their position.

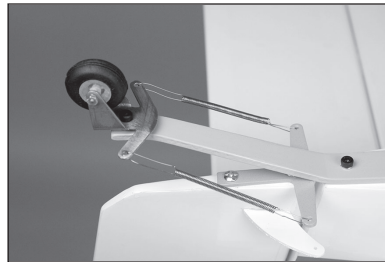

## ELEVATOR SERVO INSTALLATION

87. Install the elevator servo in the fuselage using the hardware included with the servo. The output of the servo faces toward the front of the fuselage. Make sure to prepare the screw holes following steps outlined earlier in this manual.

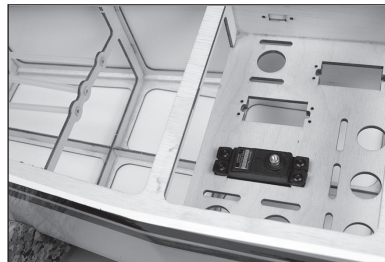

88. Center the elevator servo using the radio system. Attach the servo arm to the servo so it is parallel to the servo centerline. Remove any arms from the servo horn that will interfere with the operation of the servo and linkage using side cutters.

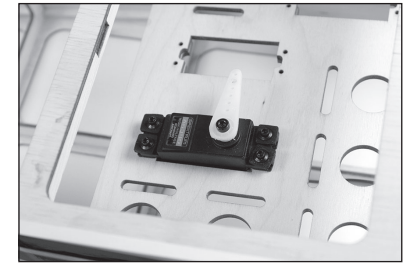

89. When attaching the linkage to the servo arm, use the hole that is 13/16 in (21mm) from the center of the servo horn. This hole will need to be enlarged using a pin vise and 5/64-inch (2mm) drill bit.

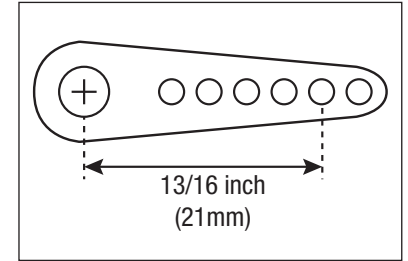

90. Attach the bend in the 3 7/8 inch (98mm) to the servo arm.

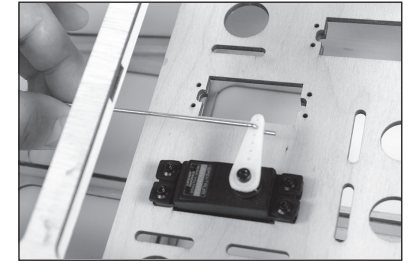

91. Remove the clevis and nut from the two 23 5/8 inch (600mm) pushrods. Slide both pushrods through the tubes in the fuselage. The pushrods will exit under the stabilizer.

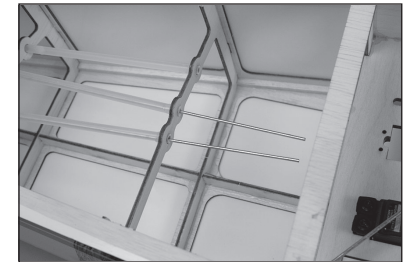

92. Thread the nut, then the clevis, on the pushrod. The end of the pushrod will protrude slightly between the forks of the clevis.

- ➔ Attach the pushrods for both elevator halves.



93. Slide the elevator pushrod connector on the pushrod from the servo. The pushrod will be in the center hole of the connector.

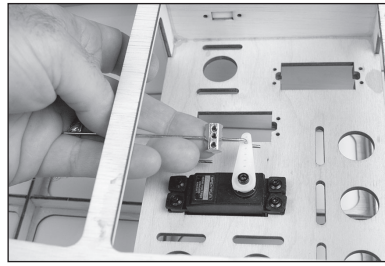

94. Slice the connector toward the servo. The two elevator pushrods can then be inserted into the outer holes of the connector.

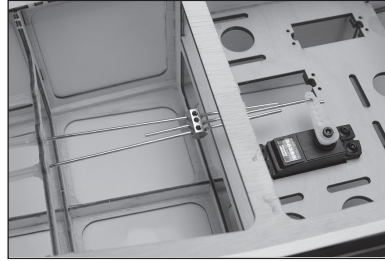

95. Position the connector so it is centered between the elevator and servo pushrods. Place a drop of threadlock on each setscrew as they are tightened into position. Setscrews will be used to secure both elevator pushrod and the pushrod from the servo.



## RUDDER SERVO INSTALLATION

96. Install the rudder servo in the fuselage using the hardware included with the servo. The output of the servo faces toward the front of the fuselage. Make sure to prepare the screw holes following steps outlined earlier on this manual.

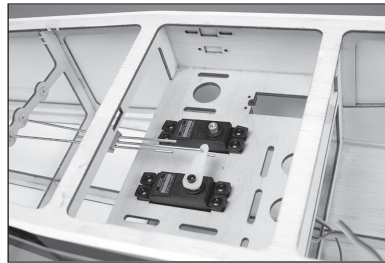

97. When attaching the linkage to the servo arm, use the hole that is 1 inch (25mm) from the center of the servo horn. This hole will need to be enlarged using a pin vise and 5/64-inch (2mm) drill bit.

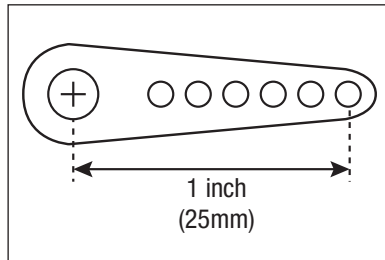

98. Attach the bend in the 26<sup>3</sup>/<sub>4</sub> inch (680mm) to the servo arm. Remove any arms from the servo horn that will interfere with the operation of the servo and linkage using side cutters.

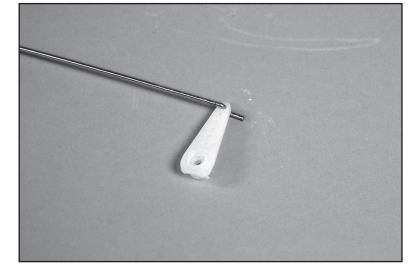

- The arm will attach perpendicular to the servo centerline. Check this alignment before attaching the pushrod and removing any of the servo arms.

99. Center the rudder servo using the radio system. Remove the clevis and nut from the rudder pushrod and slide it into the rudder pushrod tube in the fuselage. Attach the servo arm to the servo. Remove any arms from the servo horn that will interfere with the operation of the servo and linkage using side cutters.

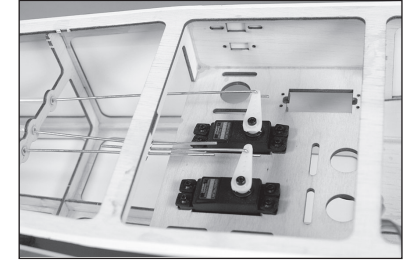

100. Thread the nut, then the clevis, on the pushrod. Attach the clevis to the rudder control horn. With the rudder servo centered, adjust the clevis to center the rudder.



- Slide the silicone retainer over the forks of the rudder and elevator clevises. Thread the nut away from the clevis. Apply a drop of threadlock on the threads near the clevis. Use pliers to tighten the nut against the clevis.

## RECEIVER AND RECEIVER BATTERY INSTALLATION

101. Secure the receiver in the fuselage and route the antenna as outlined in the receiver or radio manual. Connect the rudder and elevator servo leads to the appropriate ports on the receiver.

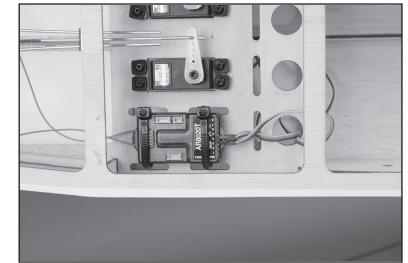

102. Remove the covering from the side of the fuselage using a hobby knife and #11 blade. Mount the receiver switch and connect the appropriate lead to the receiver.

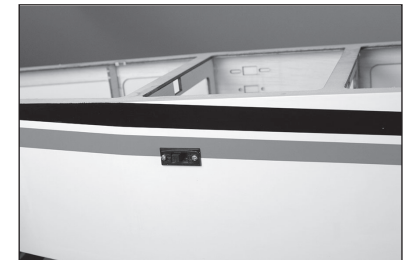



**103.** Secure the receiver battery in the fuselage using hook and loop tape and tie wraps. Secure the lead from the battery to the receiver switch.

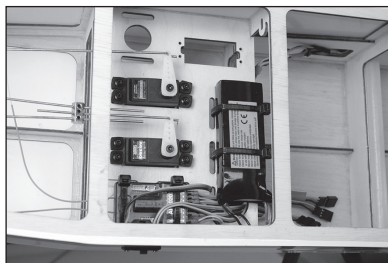

→ The receiver batteries can also be mounted on the bottom of the fuselage to provide more room on the servo tray.

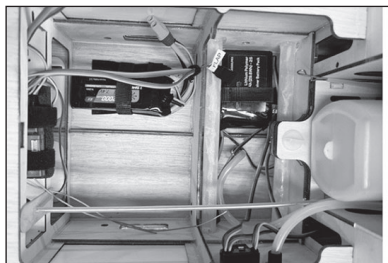

## LANDING GEAR INSTALLATION

**104.** Use two 1/2-inch wrenches to attach the axle to the landing gear

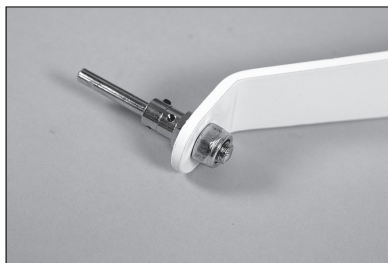

**105.** Loosen the setscrews in the wheel collars using a 1.5mm hex wrench. Remove the outer wheel collar. Slide the remaining wheel collar tight against the hex and tighten the setscrew.

→ Apply a drop of threadlock on the setscrew before tightening to prevent it from loosening.



**106.** Apply a drop of light machine oil on the axle.



**107.** Fit the wheel to the axle, then install the remaining wheel collar on the axle. Make sure the setscrew is tightened on the flat area made on the axle.

→ Apply a drop of threadlock on the setscrew before tightening to prevent it from loosening.

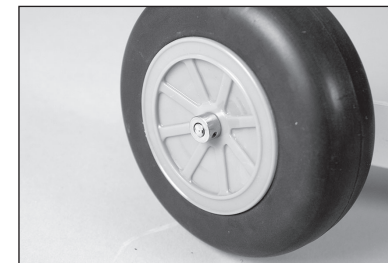

**108.** Attach the landing gear to the fuselage using four M4 x 20 socket head cap screws and four M4 washers. Tighten the screws using a 3mm hex wrench.

→ Apply a drop of threadlock on each screw to prevent it from loosening.

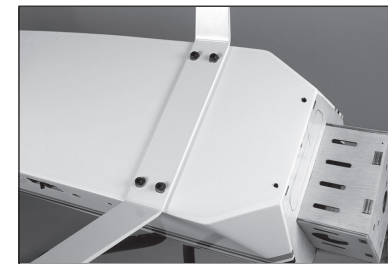

## ELECTRIC MOTOR INSTALLATION

**109.** Use a pencil to extend the centerlines on the motor box.

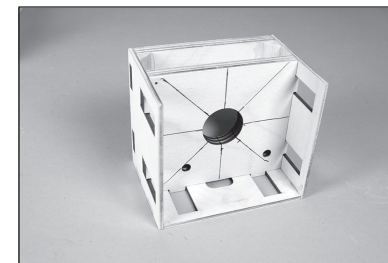

**110.** Place the X-mount on the motor box. Align the holes in the mount with the lines on the motor box. Mark the location for the mounting holes on the motor box using a pencil.

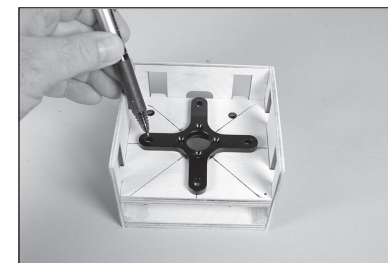



**111.** Remove the mount and drill the holes for the motor mounting screws using drill and 7/32-inch (5.5mm) drill bit.

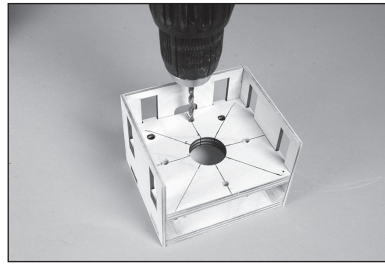

**112.** Use a #2 Phillips screwdriver to attach the X-mount to the rear of the motor. Use a 2.5mm hex wrench to attach the propeller adapter to the front of the motor. Use thread lock on all metal-to-metal fasteners to prevent them from vibrating loose.



**113.** Use two M4 x 20 socket head cap screws, two M4 washers and two M4 lock nuts to temporarily attach the motor to the motor box plate



**114.** Position the motor box plate fully forward when using the recommended Spektrum Avian motor. The mount is adjustable for a variety of motors.

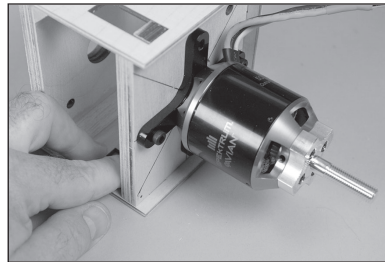

**115.** Position the plate so the distance from the face of the drive washer to the back of the motor box measures 5<sup>9</sup>/<sub>16</sub> inches (141mm)

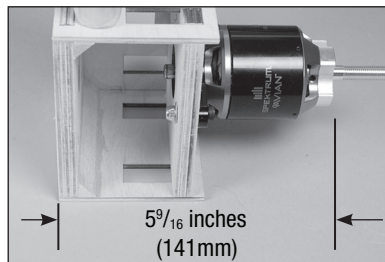

**116.** Mark the location of the plate and remove the motor from the motor box plate.

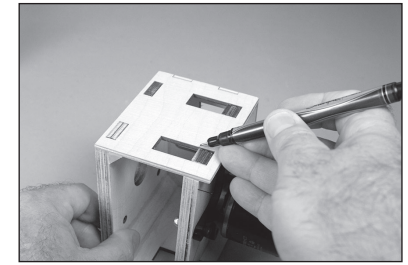

**117.** Slide the plate back and apply a thin coat of 30-minute epoxy to the motor box where the plate comes in contact with the box.

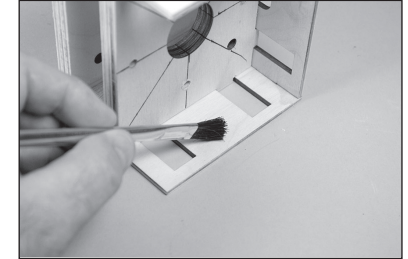

**118.** Slide the plate forward. Use a paper towel and isopropyl alcohol to remove any excess epoxy. Use tape to hold the sides of the motor box tight against the plate until the epoxy fully cures.

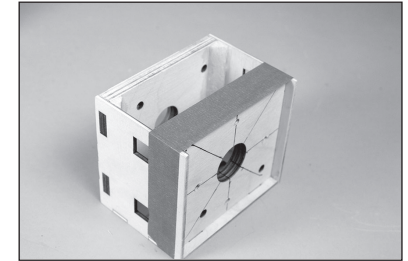

**119.** Once the epoxy fully cures, remove the tape. Install the triangle stock on the inside of the motor box. Make sure to cut the triangle stock so it does not interfere with the holes for mounting the motor and fits tight into the corners of the motor box.

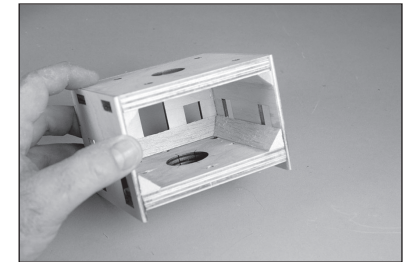

**120.** Attach the motor box to the firewall using four M4 washers and four M4 x 20 socket head cap screws. Use threadlock on the blind nuts to prevent them from vibrating loose.

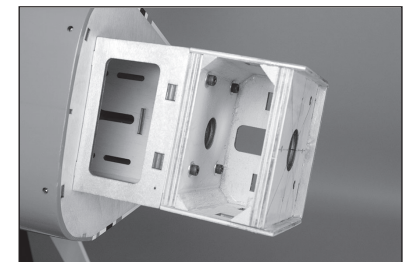

- 121.** Attach the motor box to the firewall using four M4 blind nuts, four M4 washers and four M4 x 20 socket head cap screws. Use threadlock on the blind nuts to prevent them from vibrating loose.

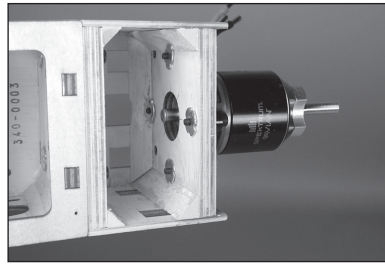

- 122.** Remove the plate from the fuselage to allow cooling air to enter the fuselage.

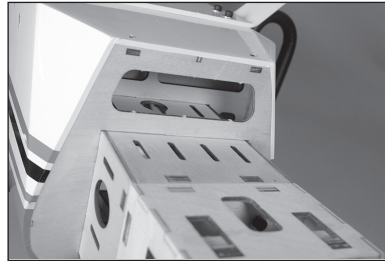

- 123.** Thread the 1/4-20 nylon bolt into the threaded insert from the bottom of the battery tray.

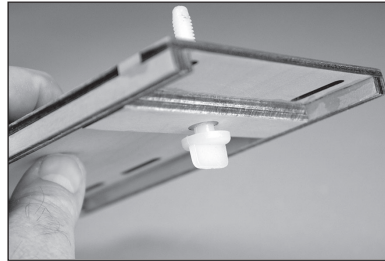

- 124.** Slide the tray into the fuselage. The head of the nylon bolt will fit into the notch in the fuselage tray. Make sure the nylon bolt is threaded in enough to keep the tray from moving up and down inside the fuselage.

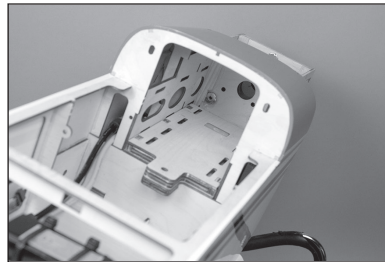

- 125.** Remove the tray from the fuselage and use side cutters to remove the excess bolt from the upper side of the tray.

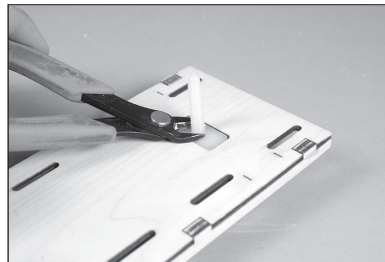

- 126.** Use a sanding block and medium grit sandpaper to sand the bolt flush with the top of the tray so it doesn't damage the battery when they are mounted to the tray.

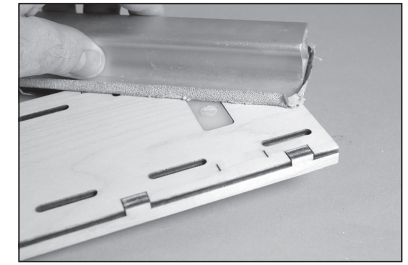

- 127.** Apply hook and loop tape to the battery tray.

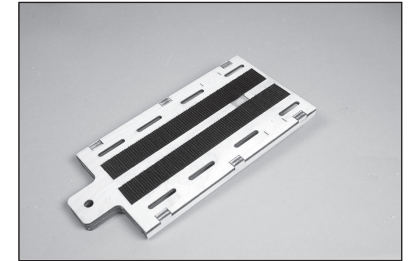

- 128.** Use the hook and loop straps and tape to secure the batteries to the battery tray.

- Make sure not to cover any warning labels on the battery.

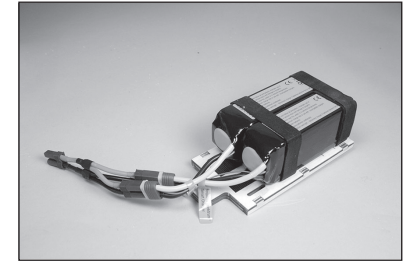

- The Brave can be powered by two batteries in parallel, or a single battery. Both options are shown.

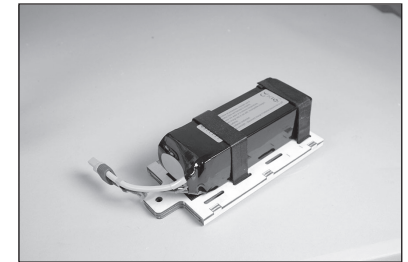

- 129.** Slide the tray with the battery into the fuselage. The tray is then secured at the rear using a 1/4-20 nylon bolt.

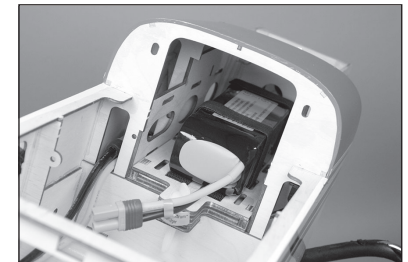

## GAS ENGINE INSTALLATION

**130.** Attach the engine mount to the firewall using four M4 x 30 machine screws and four M4 washers. Place a drop of threadlock on each screw before their installation. Use a #2 Phillips screwdriver to tighten the screws once both mounts have been positioned correctly on the firewall.

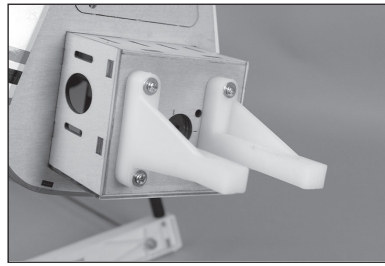

**131.** Fit the engine between the engine mounts. Adjust the engine so the face of the drive washer is  $5\frac{9}{16}$ -inches (141mm) forward of the firewall.

→ Use a clamp to hold the engine secure for the following steps.

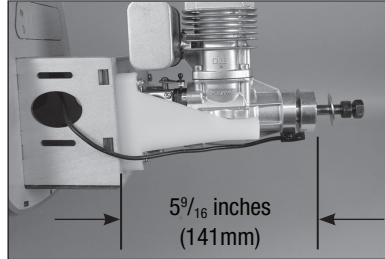

**132.** Use a felt-tipped pen to mark the location for the four engine mounting bolts on the engine mount.

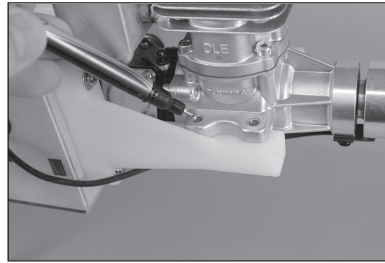

**133.** Remove the engine from the mounts. Use a drill and 11/64-inch (4.5mm) drill bit to drill the holes for the engine mounting screws.



**134.** Mark the location of the throttle pushrod on the firewall using a sharpened wire or felt-tipped pen. Remove the engine from the mount.

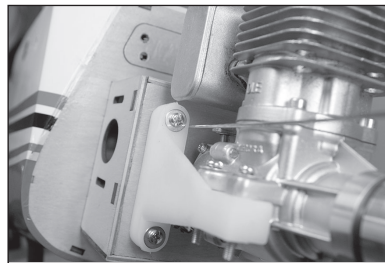

**135.** Use a drill and 5/32-inch (4mm) drill bit to drill the hole for the throttle pushrod.



**136.** Slide the throttle pushrod tube into the hole in the firewall. Once installed, the tube will protrude 1/16 inch (1.5mm) from the firewall.

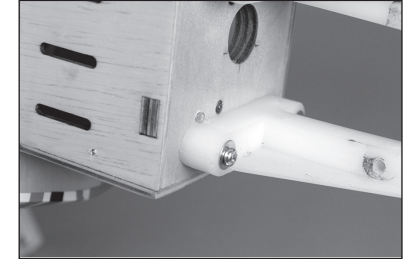

**137.** Guide the pushrod tube through the fuselage toward the throttle servo. Make sure the tube does not make any extreme bends that could cause the pushrod to bind inside the tube.

→ The servo tray has locations on either side of the fuselage for the throttle servo. Use the location that best suits the engine selected for your model.

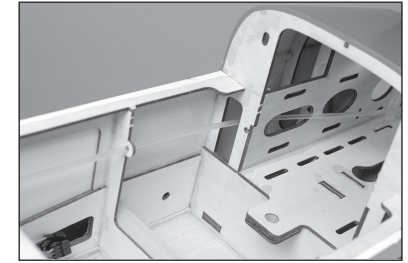

**138.** Trim the pushrod tube 1/4 inch (6mm) behind the former that support the radio tray in the fuselage using side cutters. Use medium CA to glue the tube in the fuselage.

→ Make sure the CA does not enter the tube, which could glue the pushrod wire to the tube.

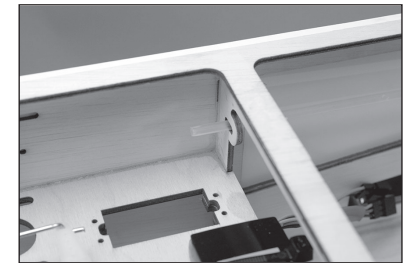
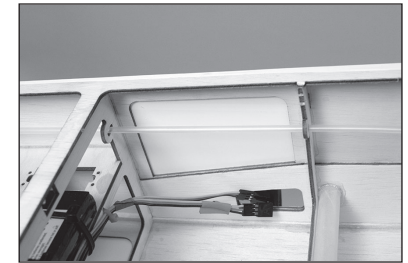



139. Slide an M4 washer on each M4 x 30 machine screw, then place an M4 locknut on each screw. Use a #2 Phillips screwdriver and 7mm hex driver to tighten all four screws, securing the engine to the engine mount.

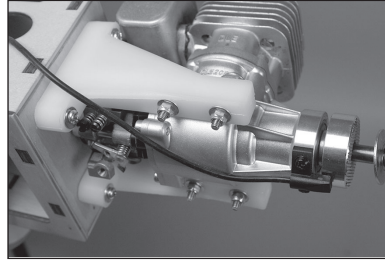
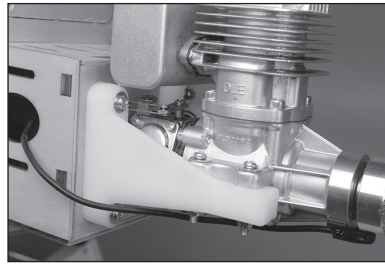

140. Install the throttle servo in the fuselage using the hardware included with the servo. The output of the servo faces toward the rear of the fuselage. Make sure to prepare the screw holes following steps outlined earlier on this manual.

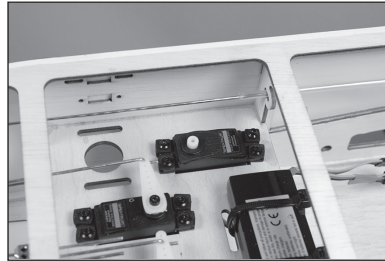

- The servo tray has locations on either side of the fuselage for the throttle servo. Use the location that best suits the engine selected for your model.

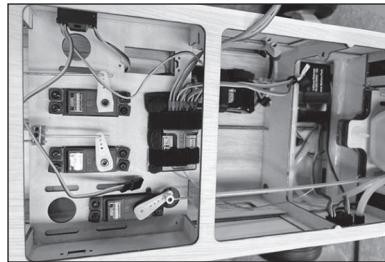

- When mounting the throttle servo on the opposite side as shown in the manual, a support must be fabricated to support the pushrod tube for the throttle pushrod to operate properly

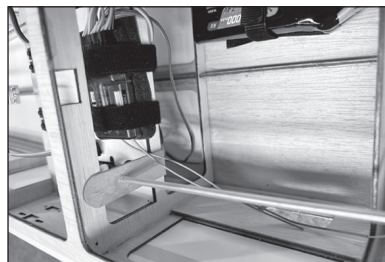

141. Mount the throttle servo connector in the throttle servo arm. Place a drop of canopy glue on the M2 nut, then install it on the underside of the arm to secure the connector.

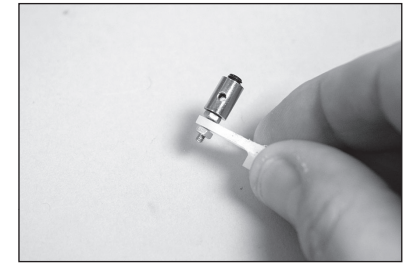

142. Center the servo using the radio system and install the servo arm on the servo, perpendicular to the servo center line

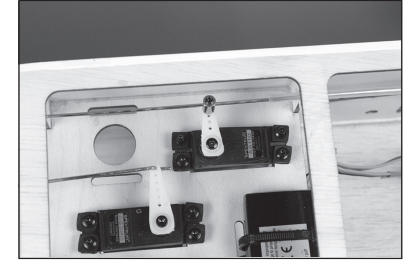

143. Move the carburetor and servo to the low-throttle position and tighten the setscrew securing the pushrod to the connector at the servo. Use side cutters to trim the excess wire. Check the operation of the carburetor using the radio system. Make any adjustments necessary to fully open and close the carburetor using the radio system.

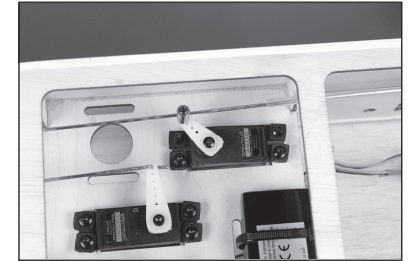

144. Check the operation of the carburetor to make sure it opens fully, and the pushrod does not bind.

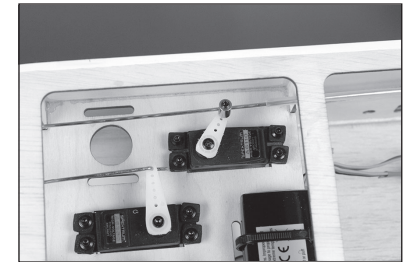

145. Use side cutters to trim and excess pushrod that may interfere with the operation of the throttle.

- The servo location opposite the throttle servo can be used to mount a choke servo.





- 146.** Secure the ignition module and receiver battery in the fuselage. Use hook and loop tape and tie wraps to secure their location. Make any connections using the instructions provided with the engine.

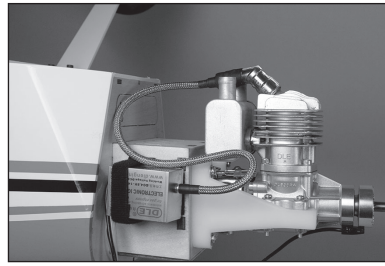

- 147.** Remove the covering from the side of the fuselage using a hobby knife and #11 blade. Mount the ignition switch and connect the appropriate lead to the ignition module and ignition battery.

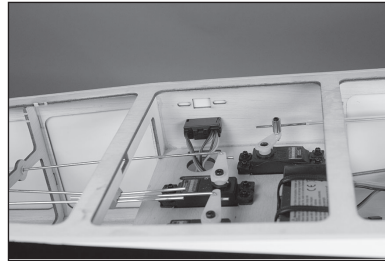

## FUEL TANK INSTALLATION

- 148.** Carefully bend the longer brass tube so it will be close to the top of the tank when the stopper has been installed.

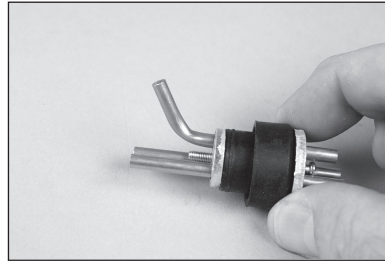

- 149.** Prepare the brass tubes by placing small amounts of solder on the end of the tubes shown. This will help keep the fuel lines secure when installed.

- Use hemostats to act as a heat-sink to avoid melting the rubber stopper.

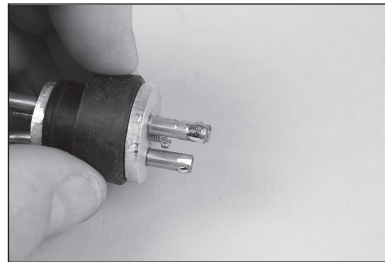

- 150.** Cut a piece of fuel tubing that will result in the end of the clunk being 5 inches (127mm) from the back of the aluminum plate. Secure the tubing to the clunk and stopper using thin wire. This will keep the tubing from sliding loose inside the tank.

- A second clunk can be installed to provide a line to fuel/defuel your aircraft.

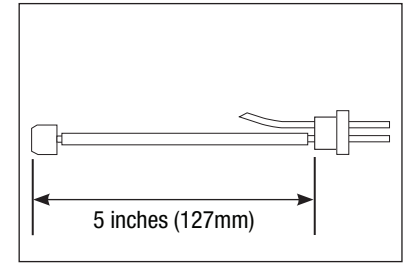

- 151.** Insert the clunks into the tank. Install the larger clunk, then the small clunk. Mark the lines from the tank so the fuel lines can be identified from outside the tank. Tighten the screw in the stopper using a #1 Phillips screwdriver.

- Check that both clunks can move freely inside the tank. If not, adjust the tubing from outside the tank so they can move freely to ensure consistent fuel flow to the engine.



- 152.** Secure a 12-inch (300mm) fuel line to the fill, vent and clunk tubes of the fuel tank. Tie wraps can be used to secure the fuel lines as an alternative to wire ties on the outside of the fuel tank.

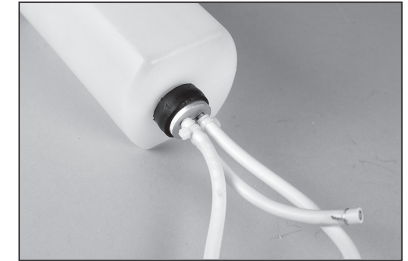

- 153.** Thread the 1/4-20 nylon bolt into the threaded insert from the bottom of the battery tray.

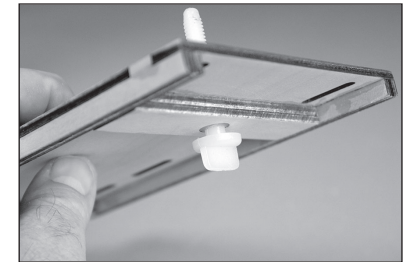

- 154.** Slide the tray into the fuselage. The head of the nylon bolt will fit into the notch in the fuselage tray. Make sure the nylon bolt is threaded in enough to keep the tray from moving up and down inside the fuselage.

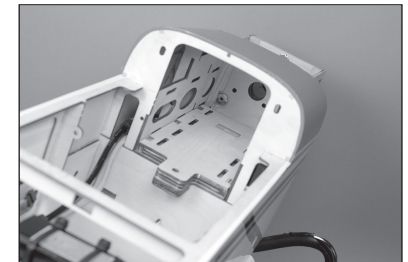

155. Remove the tray from the fuselage and use side cutters to remove the excess bolt from the upper side of the tray.

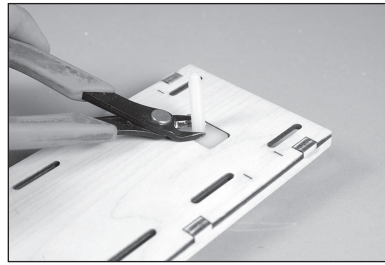

156. Use a sanding block and medium grit sandpaper to sand the bolt flush with the top of the tray so it doesn't damage the fuel tank when it is mounted to the tray.

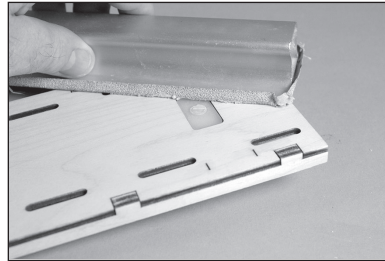

157. Use hook and loop tape and a hook and loop strap to secure the ignition battery at the front of the fuel tank tray.

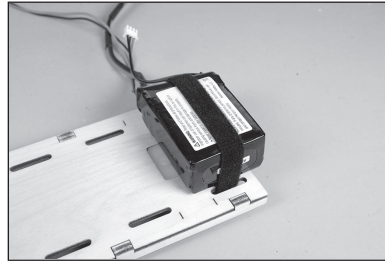

158. Use tie wraps to secure the fuel tank to the fuel tank tray.

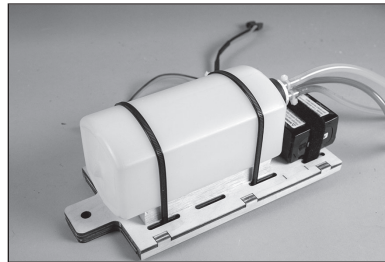

159. Fit the fuel tank tray into the fuselage. Use a 1/4-20 nylon bolt to secure the tray in the fuselage.

➔ Check that the tank and battery are far enough forward that the cockpit hatch will fit on the fuselage.



160. Install a fuel filler in the side of the fuselage and route the fuel fill line.

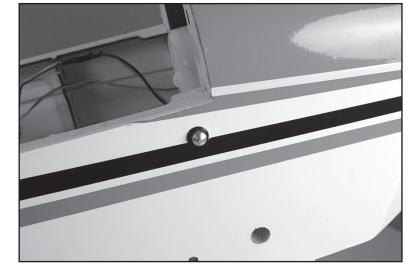

161. The vent line fitting is mounted on the underside of the fuselage. Attach the vent line to the fitting.



## COWLING INSTALLATION

162. Cut four pieces of card stock and make a small hole near the end of each piece. Use an M3 x 10 button head screw to align the hole with the blind nuts in the fuselage. Tape the card stock to the top and bottom of the fuselage.

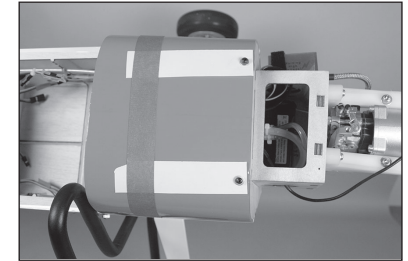

163. Slide the cowl on the fuselage. The spinner backplate is then positioned. When aligning the cowl, the space between the cowl and spinner will be equal.



164. It may be necessary to trim the cowl to clear the muffler before the cowl can be properly aligned.

➔ The muffler can be removed to make fitting the cowl easier. This will require removing the engine from the mount.

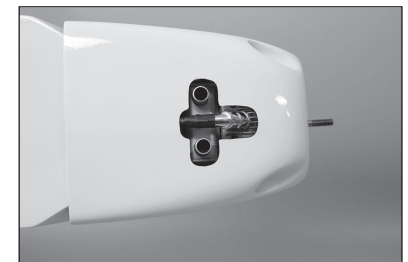

**165.** Fit the spinner cone to the spinner backplate to continue checking the cowl alignment. The cowl will sit slightly higher than the spinner, which is scale for this aircraft. There will be a 1/8 inch (3mm) gap between the spinner backplate and front of the cowl.

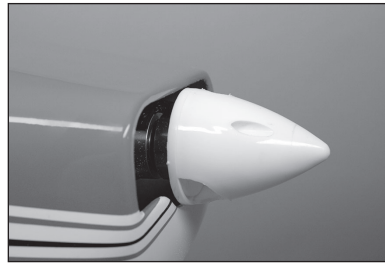

**166.** Once aligned, mark the locations for the cowl mounting screws on the cowl using a felt-tipped pen.

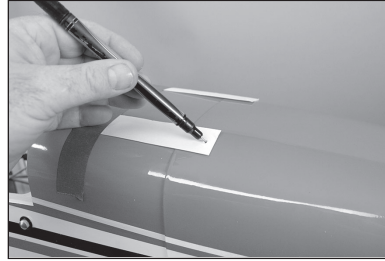

**167.** Remove the cowl and use a pin vise and 1/8-inch (3mm) drill bit to drill the four holes for the cowl mounting screws.

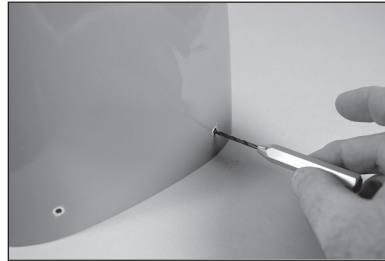

**168.** Glue the exhaust on the left and right sides of the cowling using a flexible adhesive.



**169.** Secure the cowl using four M3 x 10 button head screws and four M3 washers.



**170.** Secure the propeller and spinner backplate to the engine shaft. Attach the spinner cone using the screws provided with the spinner. Trim the openings around the propeller, if necessary, as the propeller must not come in contact with the spinner cone when installed.

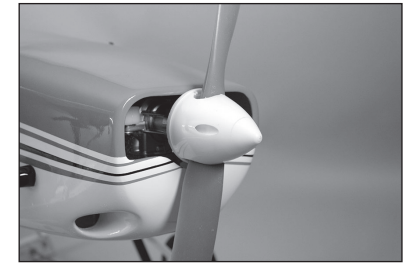

→ Use your preferred method to operate the choke from outside the cowling if a choke servo has not been installed.

→ When flying in higher temperatures, the cowling can be modified to force more air over the engine. Trim the cowling to provide an additional air inlet to the engine.

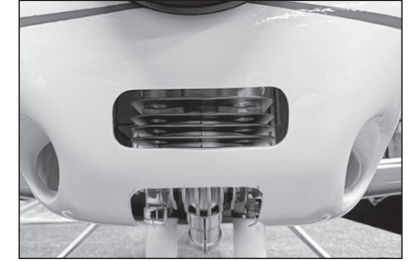

→ If the additional air opening does not resolve any overheating issues, start by blocking the openings around the spinner using light plywood or foam board.



→ Trim the cowling around the engine, then use light plywood or foam board to create a baffle that will direct air directly over the engine.

→ Paint the baffles using paint that is compatible with the materials used to create the baffles.

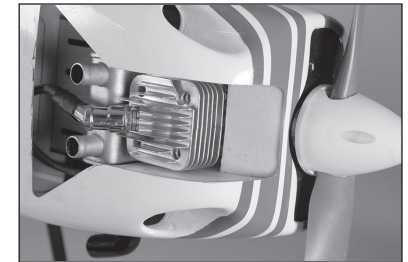

## CANOPY HATCH ASSEMBLY

### Optional Viewing Window Installation

**171.** Use a hobby knife with a #11 blade to remove the covering for the viewing window in the cockpit.

→ Seal the covering into the edges of the opening. This will give a cleaner appearance as well as prevent peeling of the covering from the canopy hatch..

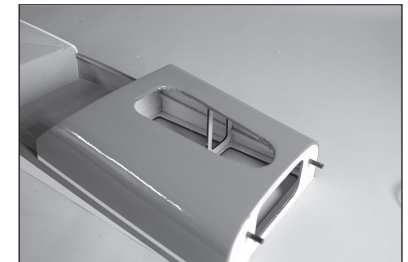



172. Trim the viewing window using hobby scissors and a hobby knife with a #11 blade.

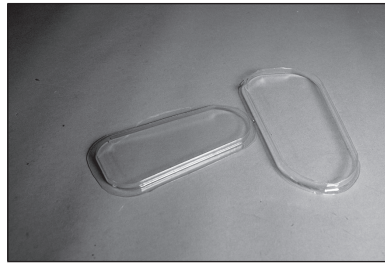

173. Use canopy glue to attach the viewing window to the cockpit. Use low-tack tape to hold the viewing window in position until the adhesive fully cures.

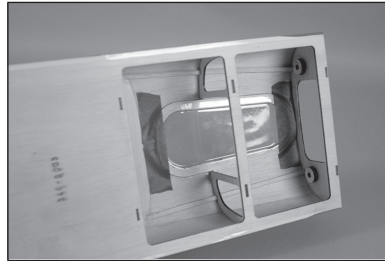

174. Use a flexible adhesive to secure the pilot in the cockpit.



175. Use canopy glue to attach the canopy to the cockpit. Use low-tack tape to hold the canopy in position until the adhesive fully cures.



## CENTER OF GRAVITY

 CAUTION: You must adjust your aircraft's center of gravity and balance your model properly before attempting flights.

An important part of preparing the aircraft for flight is properly balancing the model. The Center of Gravity range supplied here is a guideline based on testing. Deviation from the measurements we provide is possible and may result in a model that suits your flying style better. Start with the recommended Center of Gravity, then feel free to experiment with different balance points. We advise adjusting progressively and cautiously.

1. Attach the wing panels to the fuselage. Make sure to connect the leads from the aileron and flaps to the appropriate leads from the receiver. Make sure the leads are not exposed outside the fuselage before tightening the wing bolts. Your model should be flight-ready before balancing.
  2. The recommended Center of Gravity (CG) location for your model is  $5\frac{1}{8}$  inches (130mm) behind the leading edge of the wing against the fuselage for sport flying.
  3. When balancing your model, make sure it is assembled and ready for flight. Support the plane inverted at the marks made on the wing with your fingers or a commercially available balancing stand.
- ➔ The overall CG range for this model is  $4\frac{11}{16}$ – $5\frac{1}{2}$  inches (120–140mm). We recommend starting at the measurement listed above, then adjusting to suit your particular flying style.
- ➔ Nose weight may be required when using lighter engines. Move the batteries as far forward in the fuselage to help reduce the amount of weight required.

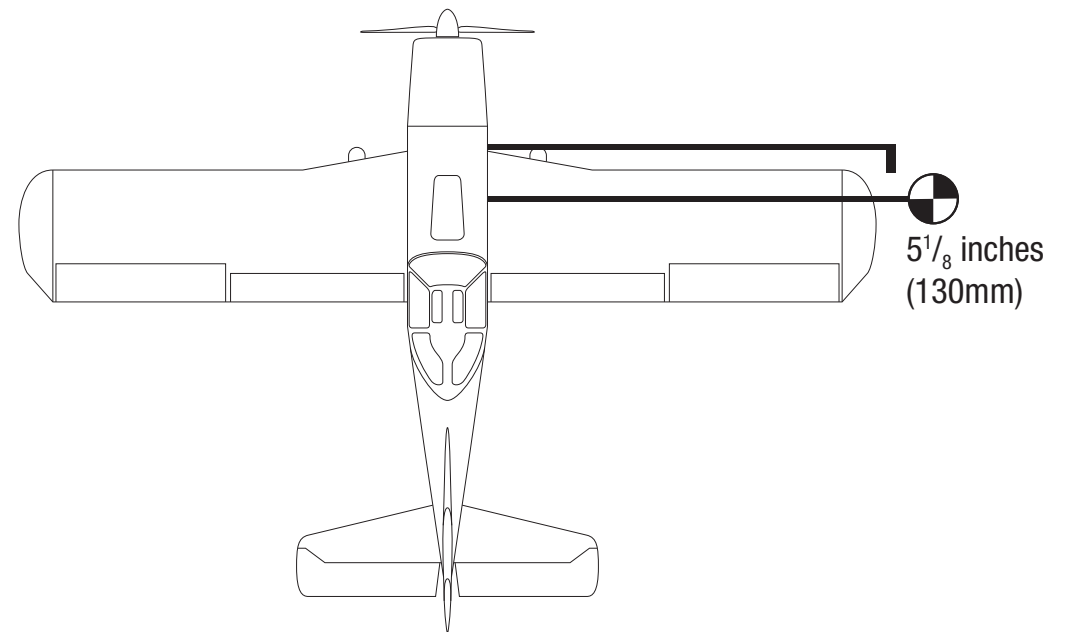

## CONTROL THROWS

1. Turn on the transmitter and receiver of your model. Check the movement of the rudder using the transmitter. When the stick is moved to the right, the rudder should also move right. Reverse the direction of the servo at the transmitter if necessary.
2. Check the movement of the elevator with the radio system. Moving the elevator stick toward the bottom of the transmitter will make the airplane elevator move up.
3. Check the movement of the ailerons with the radio system. Moving the aileron stick to the right will make the right aileron move up and the left aileron move down.
4. Use a ruler to adjust the throw of the elevator, ailerons and rudder.

| Surface  | Rate | Direction | Throw   |
|----------|------|-----------|---|
| Aileron  | High | Up        | 1 <sup>25</sup> / <sub>32</sub> inches (45mm) |
|          |      | Down      | 1 <sup>3</sup> / <sub>8</sub> inches (35mm)   |
|          | Low  | Up        | 1 inches (25mm)                               |
|          |      | Down      | 23/32 inches (20mm)                           |
| Elevator | High | Up        | 11/16 inches (18mm)                           |
|          |      | Down      | 11/16 inches (18mm)                           |
|          | Low  | Up        | 1/2 inches (12mm)                             |
|          |      | Down      | 1/2 inches (12mm)                             |
| Rudder   | High | Left      | 1 <sup>31</sup> / <sub>32</sub> inches (50mm) |
|          |      | Right     | 1 <sup>31</sup> / <sub>32</sub> inches (50mm) |
|          | Low  | Left      | 1 <sup>3</sup> / <sub>16</sub> inches (30mm)  |
|          |      | Right     | 1 <sup>3</sup> / <sub>16</sub> inches (30mm)  |
| Flaps    |      | Take-Off  | 1 inches (25mm)                               |
|          |      | Landing   | 2 <sup>11</sup> / <sub>32</sub> inches (60mm) |

### Flap to Elevator Mixing:

Mixing the elevator to the flaps will eliminate any pitch changes when the flaps are applied. This will make take-off and landing much smoother. We recommend mixing 1/32–3/32 inch (1–2mm) of down elevator to full down flap.

These are general guidelines for general sport and aerobatic flying from our own flight tests. You can experiment with higher or lower rates to match your preferred style of flying.

Travel Adjust and Sub-Trims are not listed and should be adjusted according to each individual model and preference. Always install the control horns 90 degrees to the servo center line. Use sub-trim as a last resort to center the servos. Always re-bind the radio system once all the control throws are set to keep the servos from moving to their endpoints until the transmitter and receiver connect.

## PREFLIGHT CHECKLIST

- Charge the transmitter, receiver and motor batteries. Follow the instructions provided with the charger. Follow all manufacturer's instructions for your electronic components.
- Check the radio installation and make sure all control surfaces (aileron, elevator, rudder, and flaps) move correctly (i.e., the correct direction and with the recommended throws).
- Check all the hardware (control horns, servo horns, and clevises) to make sure they are secure and in good condition.
- Prior to each flying session (and especially with a new model), perform a range check of your radio system. See your radio manual for the recommended range and instructions for your particular radio system.

## DAILY FLIGHT CHECKS

- Check the battery voltage of the transmitter battery. Do not fly below the manufacturer's recommended voltage. Doing so can cause your aircraft to crash.
- Check all hardware (linkages, screws, nuts, and bolts) prior to each day's flight. Ensure that binding does not occur and that all parts are properly secured.
- Ensure all surfaces are moving in the proper manner.
- Perform a ground range check before each day's flying session.
- All servo leads and switch harness plugs should be secured in the receiver.

## LIMITED WARRANTY

### What this Warranty Covers

Horizon Hobby, LLC, (Horizon) warrants to the original purchaser that the product purchased (the "Product") will be free from defects in materials and workmanship at the date of purchase.

### What is Not Covered

This warranty is not transferable and does not cover (i) cosmetic damage, (ii) damage due to acts of God, accident, misuse, abuse, negligence, commercial use, or due to improper use, installation, operation or maintenance, (iii) modification of or to any part of the Product, (iv) attempted service by anyone other than a Horizon Hobby authorized service center, (v) Product not purchased from an authorized Horizon dealer, (vi) Product not compliant with applicable technical regulations, or (vii) use that violates any applicable laws, rules, or regulations.

OTHER THAN THE EXPRESS WARRANTY ABOVE, HORIZON MAKES NO OTHER WARRANTY OR REPRESENTATION, AND HEREBY DISCLAIMS ANY AND ALL IMPLIED WARRANTIES, INCLUDING, WITHOUT LIMITATION, THE IMPLIED WARRANTIES OF NON-INFRINGEMENT, MERCHANTABILITY AND FITNESS FOR A PARTICULAR PURPOSE. THE PURCHASER ACKNOWLEDGES THAT THEY ALONE HAVE DETERMINED THAT THE PRODUCT WILL SUITABLY MEET THE REQUIREMENTS OF THE PURCHASER'S INTENDED USE.

### Purchaser's Remedy

Horizon's sole obligation and purchaser's sole and exclusive remedy shall be that Horizon will, at its option, either (i) service, or (ii) replace, any Product determined by Horizon to be defective. Horizon reserves the right to inspect any and all Product(s) involved in a warranty claim. Service or replacement decisions are at the sole discretion of Horizon. Proof of purchase is required for all warranty claims. SERVICE OR REPLACEMENT AS PROVIDED UNDER THIS WARRANTY IS THE PURCHASER'S SOLE AND EXCLUSIVE REMEDY.

### Limitation of Liability

HORIZON SHALL NOT BE LIABLE FOR SPECIAL, INDIRECT, INCIDENTAL OR CONSEQUENTIAL DAMAGES, LOSS OF PROFITS OR PRODUCTION OR COMMERCIAL LOSS IN ANY WAY, REGARDLESS OF WHETHER SUCH CLAIM IS BASED IN CONTRACT, WARRANTY, TORT, NEGLIGENCE, STRICT LIABILITY OR ANY OTHER THEORY OF LIABILITY, EVEN IF HORIZON HAS BEEN ADVISED OF THE POSSIBILITY OF SUCH DAMAGES. Further, in no event shall the liability of Horizon exceed the individual price of the Product on which liability is asserted. As Horizon has no control over use, setup, final assembly, modification or misuse, no liability shall be assumed nor accepted for any resulting damage or injury. By the act of use, setup or assembly, the user accepts all resulting liability. If you as the purchaser or user are not prepared to accept the liability associated with the use of the Product, purchaser is advised to return the Product immediately in new and unused condition to the place of purchase.

### Law

These terms are governed by Illinois law (without regard to conflict of law principals). This warranty gives you specific legal rights, and you may also have other rights which vary from state to state. Horizon reserves the right to change or modify this warranty at any time without notice.

### WARRANTY SERVICES

#### Questions, Assistance, and Services

Your local hobby store and/or place of purchase cannot provide warranty support or service. Once assembly, setup or use of the Product has been started, you must contact your local distributor or Horizon directly. This will enable Horizon to better answer your questions and service you in the event that you may need any assistance. For questions or assistance, please visit our website at [www.horizonhobby.com](http://www.horizonhobby.com), submit a Product Support Inquiry, or call the toll free telephone number referenced in the Warranty and Service Contact Information section to speak with a Product Support representative.

#### Inspection or Services

If this Product needs to be inspected or serviced and is compliant in the country you live and use the Product in, please use the Horizon Online Service Request submission process found on our website or call Horizon to obtain a Return Merchandise Authorization (RMA) number. Pack the Product securely using a shipping carton. Please note that original boxes may be included, but are not designed to withstand the rigors of shipping without additional protection. Ship via a carrier that provides tracking and insurance for lost or damaged parcels, as Horizon is not responsible for merchandise until it arrives and is accepted at our facility. An Online Service Request is available at [http://www.horizonhobby.com/content/service-center\\_render-service-center](http://www.horizonhobby.com/content/service-center_render-service-center). If you do not have internet access, please contact Horizon Product Support to obtain a RMA number along with instructions for submitting your product for service. When calling Horizon, you will be asked to provide your complete name, street address, email address and phone number where you can be reached during business hours. When sending product into Horizon, please include your RMA number, a list of the included items, and a brief summary of the problem. A copy of your original sales receipt must be included for warranty consideration. Be sure your name, address, and RMA number are clearly written on the outside of the shipping carton.

**NOTICE: Do not ship LiPo batteries to Horizon. If you have any issue with a LiPo battery, please contact the appropriate Horizon Product Support office.**

#### Warranty Requirements

For Warranty consideration, you must include your original sales receipt verifying the proof-of-purchase date. Provided warranty conditions have been met, your Product will be serviced or replaced free of charge. Service or replacement decisions are at the sole discretion of Horizon.

### Non-Warranty Service

Should your service not be covered by warranty, service will be completed and payment will be required without notification or estimate of the expense unless the expense exceeds 50% of the retail purchase cost. By submitting the item for service you are agreeing to payment of the service without notification. Service estimates are available upon request. You must include this request with your item submitted for service. Non-warranty service estimates will be billed a minimum of ½ hour of labor. In addition you will be billed for return freight. Horizon accepts money orders and cashier's checks, as well as Visa, MasterCard, American Express, and Discover cards. By submitting any item to Horizon for service, you are agreeing to Horizon's Terms and Conditions found on our website [http://www.horizonhobby.com/content/service-center\\_render-service-center](http://www.horizonhobby.com/content/service-center_render-service-center).

**ATTENTION: Horizon service is limited to Product compliant in the country of use and ownership. If received, a non-compliant Product will not be serviced. Further, the sender will be responsible for arranging return shipment of the un-serviced Product, through a carrier of the sender's choice and at the sender's expense. Horizon will hold non-compliant Product for a period of 60 days from notification, after which it will be discarded.**

10/15

### WARRANTY AND SERVICE CONTACT INFORMATION

| Country of Purchase      | Horizon Hobby  | Contact Information  | Address                                       |
|--------------------------|--|--|---|
| United States of America | Horizon Service Center (Repairs and Repair Requests)   | <a href="http://servicecenter.horizonhobby.com/RequestForm/">servicecenter.horizonhobby.com/RequestForm/</a> | 2904 Research Road<br>Champaign, IL 61822     |
|                          | Horizon Product Support (Product Technical Assistance) | <a href="mailto:productsupport@horizonhobby.com">productsupport@horizonhobby.com</a><br>877-504-0233         |   |
|                          | Sales  | <a href="mailto:websales@horizonhobby.com">websales@horizonhobby.com</a><br>800-338-4639                     |   |
| European Union           | Horizon Technischer Service                            | <a href="mailto:service@horizonhobby.eu">service@horizonhobby.eu</a>   | Hanskampring 9<br>D 22885 Barsbüttel, Germany |
|                          | Sales: Horizon Hobby GmbH                              | +49 (0) 4121 2655 100  |   |

### WEEE NOTICE



This appliance is labeled in accordance with European Directive 2012/19/EU concerning waste of electrical and electronic equipment (WEEE). This label indicates that this product should not be disposed of with household waste. It should be deposited at an appropriate facility to enable recovery and recycling.





**SPECIFICATIONS • SPEZIFIKATIONEN • SPÉCIFICATIONS • SPECIFICHE**

|  |  |
|--|--|
| Wingspan • Spannweite •<br>Envergure d'aile • Apertura alare   | 87.0 in (2210 mm)  |
| Length • Länge • Longueur • Lunghezza  | 61.5 in (1562 mm)  |
| Weight • Gewicht • Poids • Peso  | 194.4 oz (5513 g)  |
| Engine • Motor • Moteur • Motore   | 2-Stroke Gas: 20cc   |
| Motor<br>EP-Motor<br>Moteur EP<br>Motore elettrico   | Electric Power: 5065-450Kv Brushless Outrunner Motor<br>Elektro Antrieb Power: 5065-450Kv BL Außenläufer-Motor<br>Moteur électrique (EP): Moteur à cage tournante sans balais<br>5065-450 kV<br>Motore elettrico: Motore 5065-450 Kv Outrunner Brushless |
| Radio System<br>Funksystem<br>Système radio<br>Radiocomando  | 6-channel (or greater) with 6–7 servos<br>6-Kanal (oder größer) mit 6–7 Servos<br>6 voies (ou plus) avec 6–7 servos<br>a 6 canali (o più) con 6–7 servo  |
| Firewall-to-backplate<br>Brandschott-zu-Rückplatte<br>Pare-feu vers plaque arrière<br>Da tagliafiamma a piastra posteriore | 5 <sup>9</sup> / <sub>16</sub> inches (141mm)  |

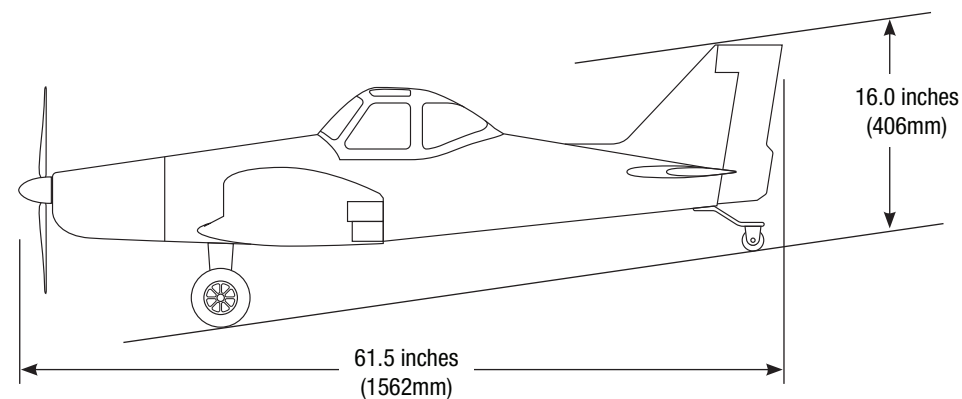
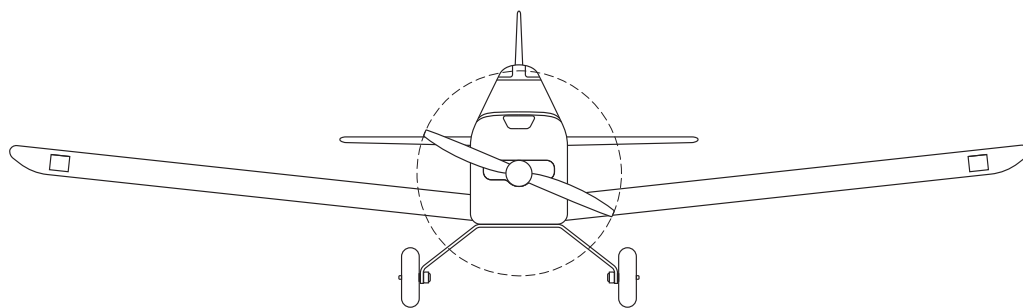
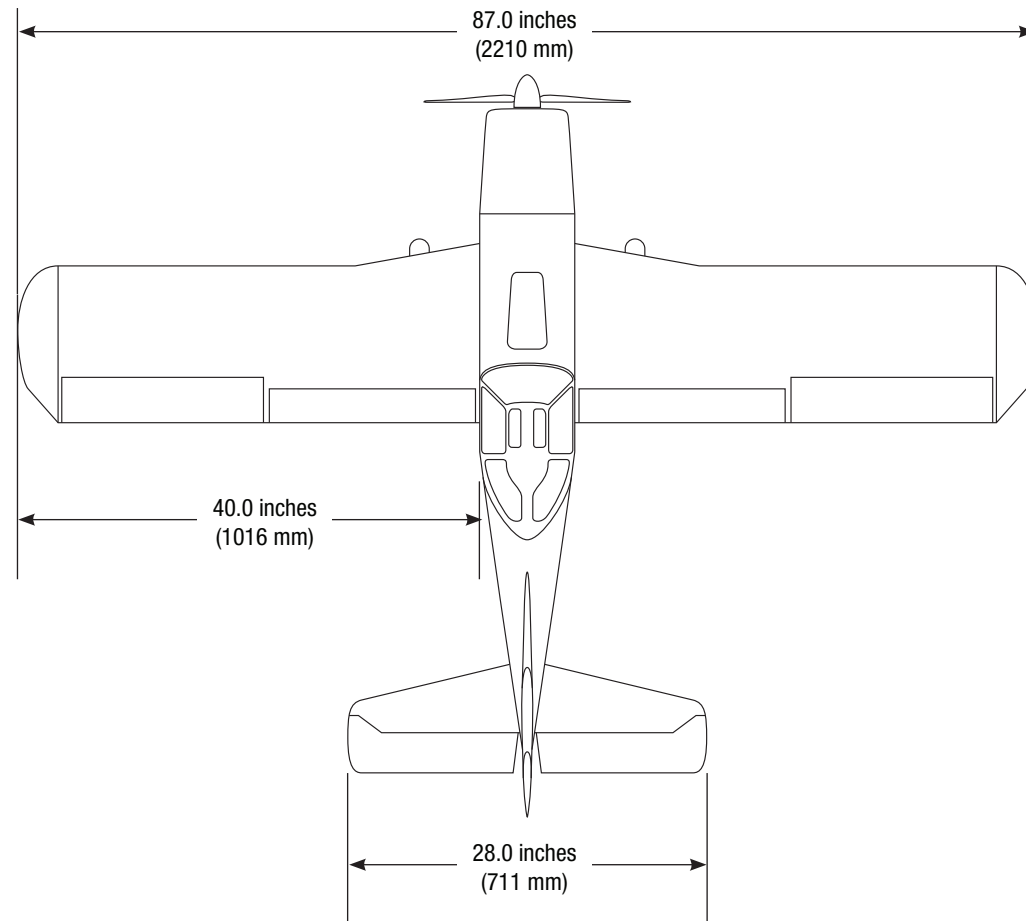





**HANGAR 9<sup>®</sup>**

© 2023 Horizon Hobby, LLC.

Hangar 9, UltraCote, IC5, EC5, AS3X and the Horizon Hobby logo are trademarks or registered trademarks of Horizon Hobby, LLC.

The Spektrum trademark is used with permission of Bachmann Industries, Inc. All other trademarks, service marks and logos are the property of their respective owners.

Updated 04/2023

238182.1 HAN7035