

Saab JAS 39 **GRIPEN**

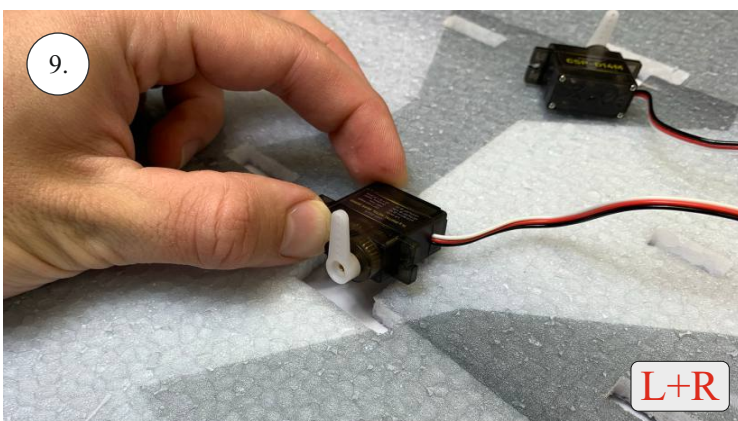

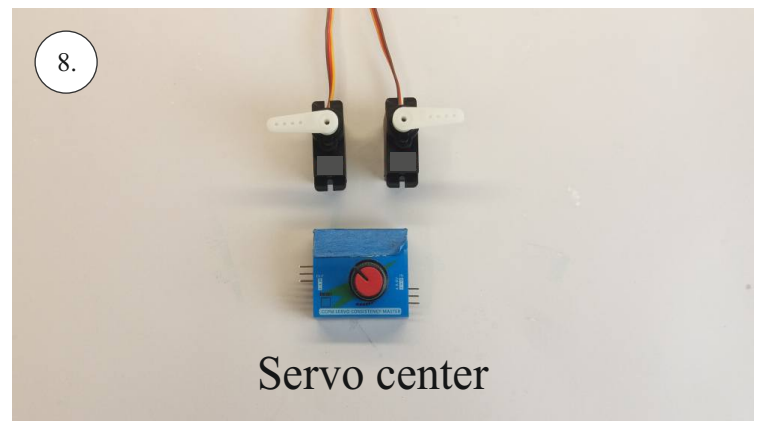

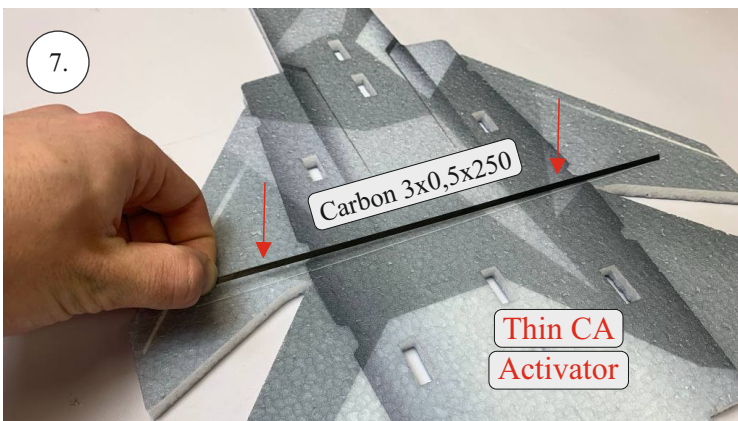

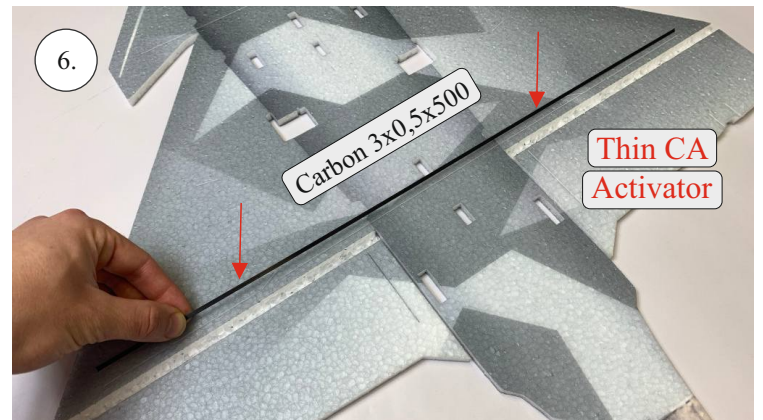
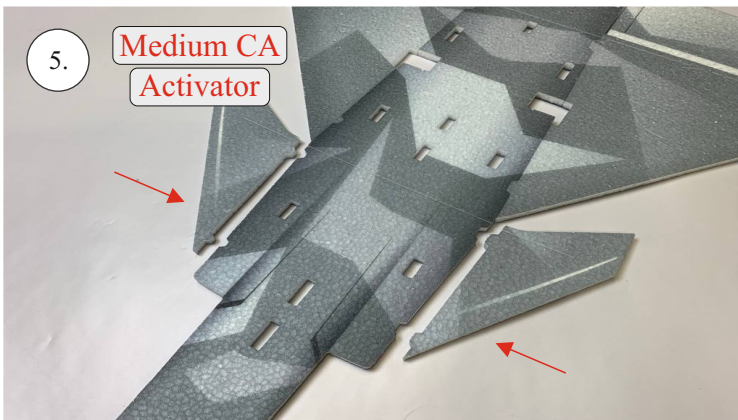
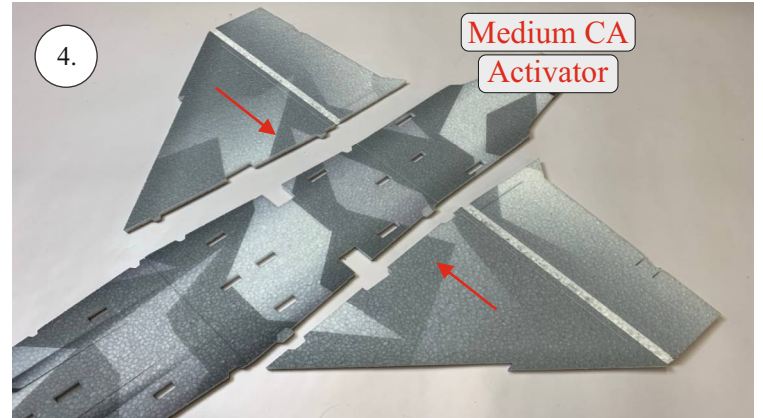
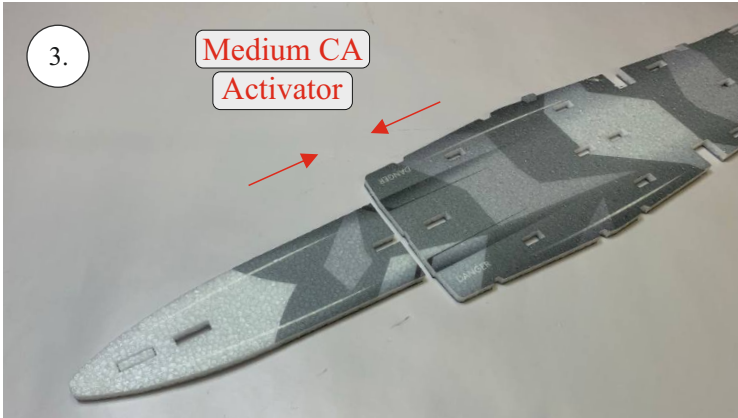
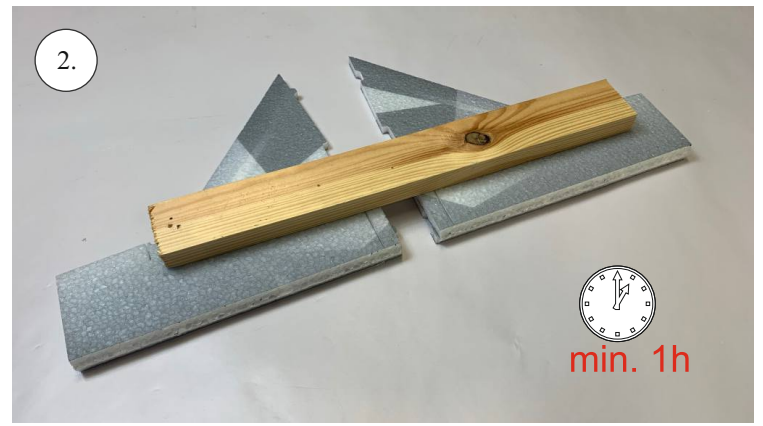
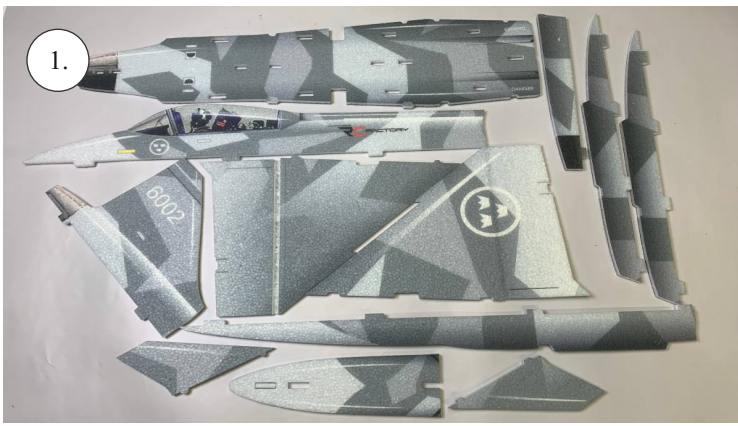
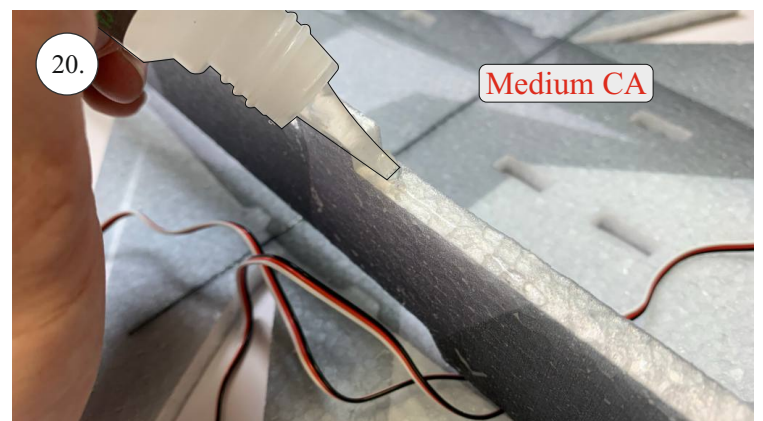
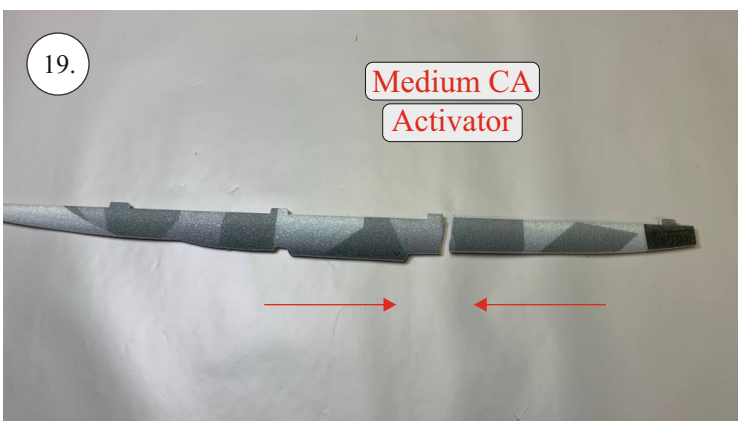
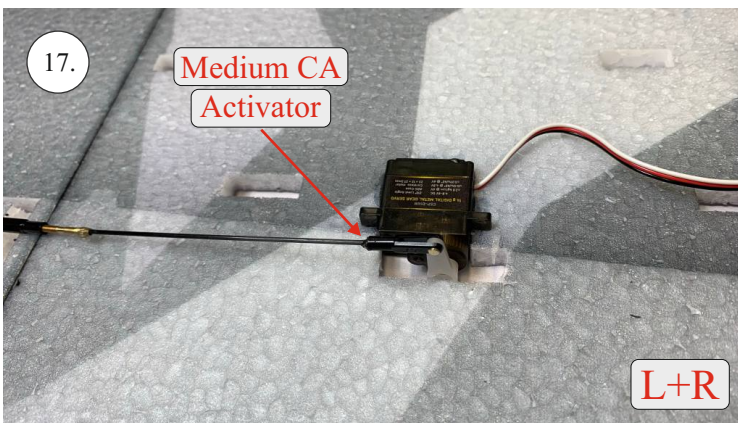
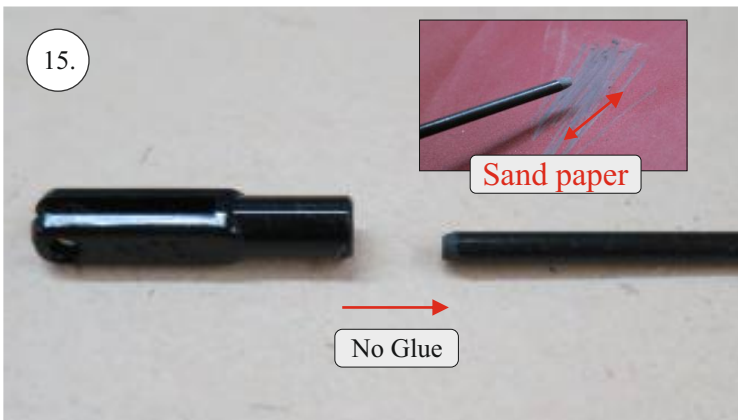
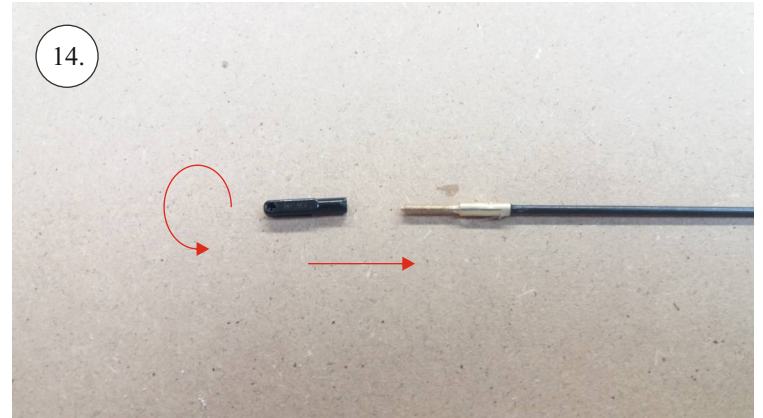
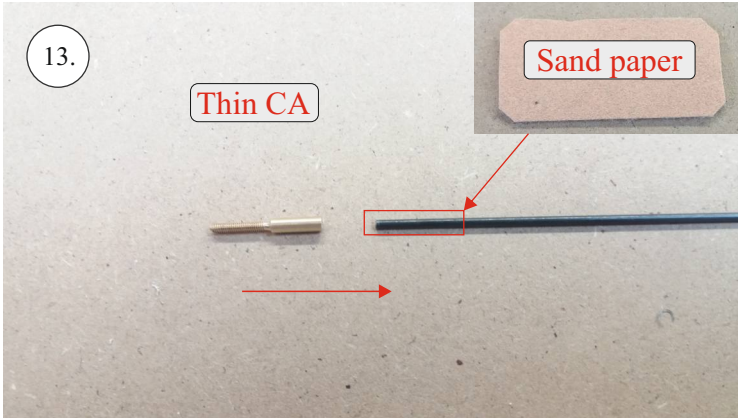
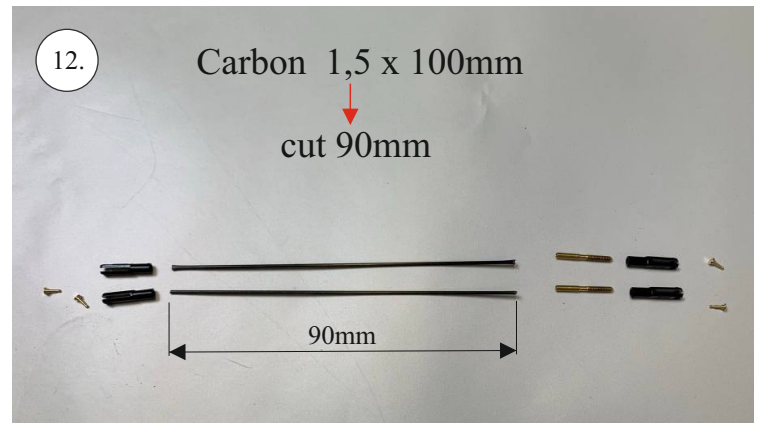
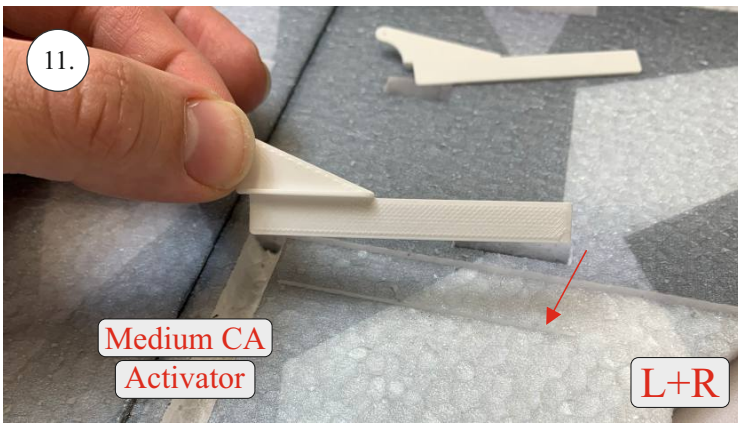
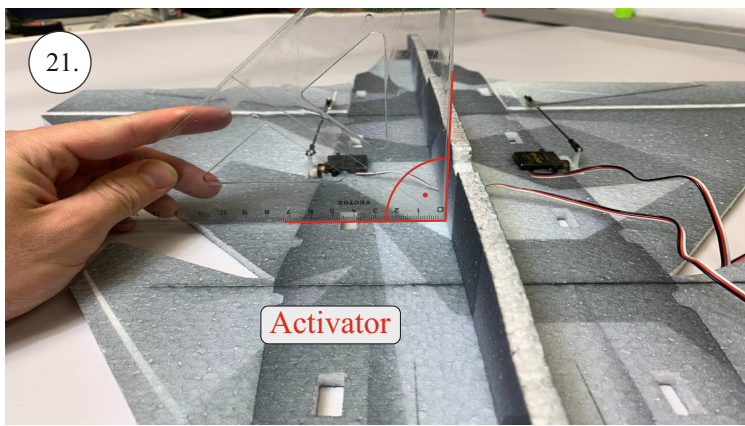

22.

Návod pokračuje dvou-motorovou verzí  
Pro jedno-motorovou verzi přeskočte  
na obr. 58

The two-engine version continues here,  
for one engine version, skip to Pic. 58

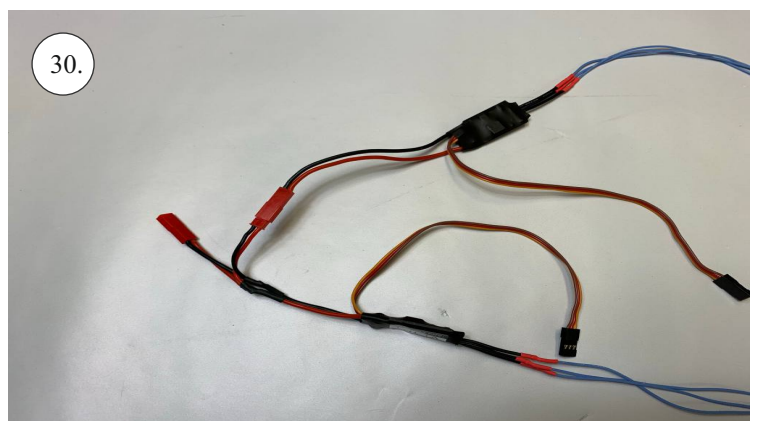
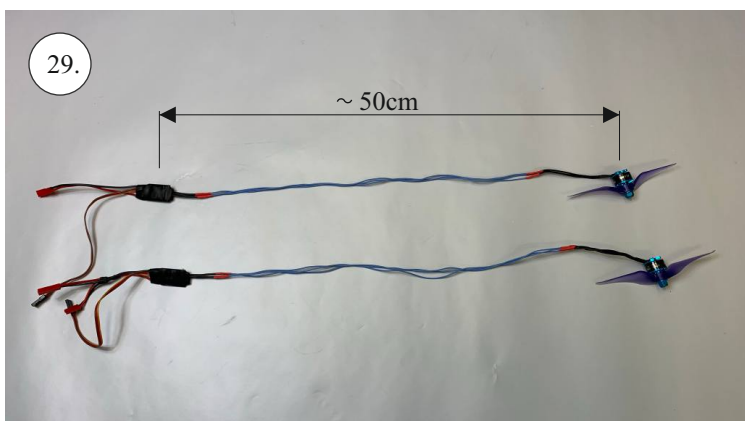
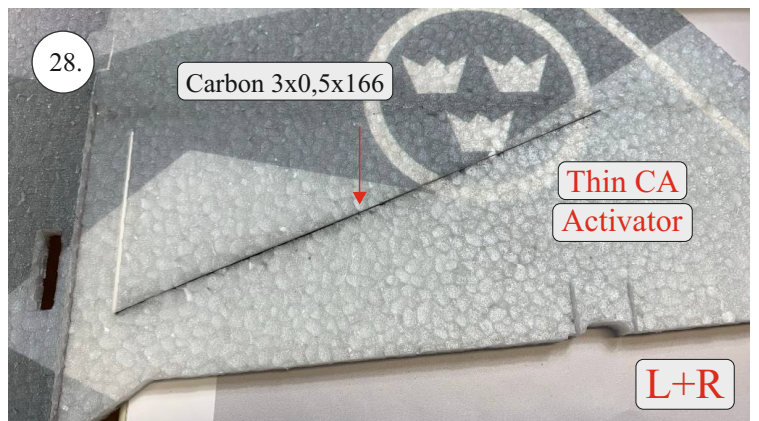
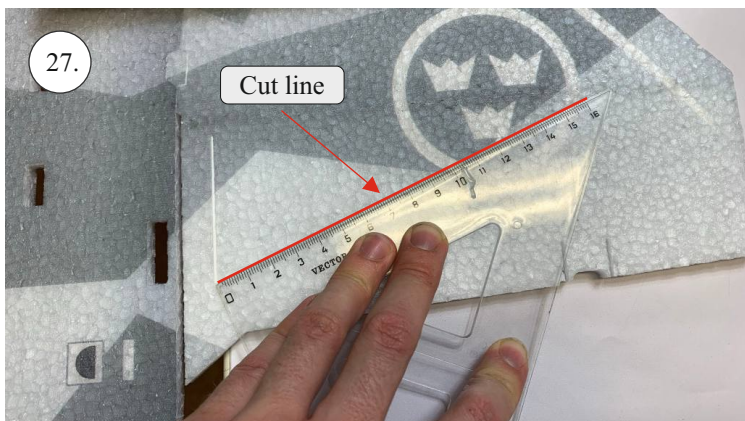
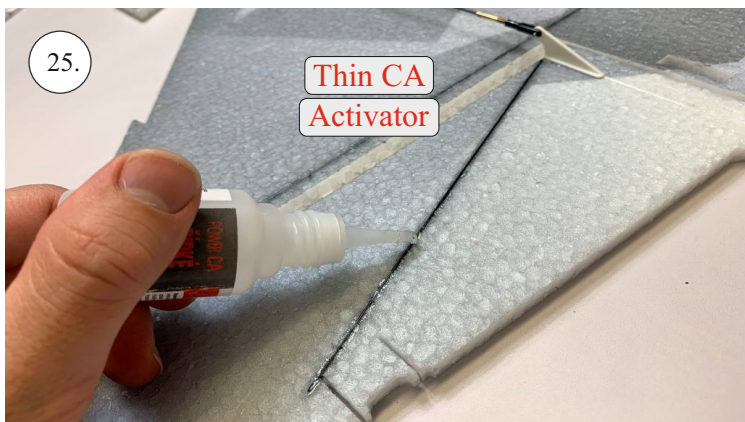
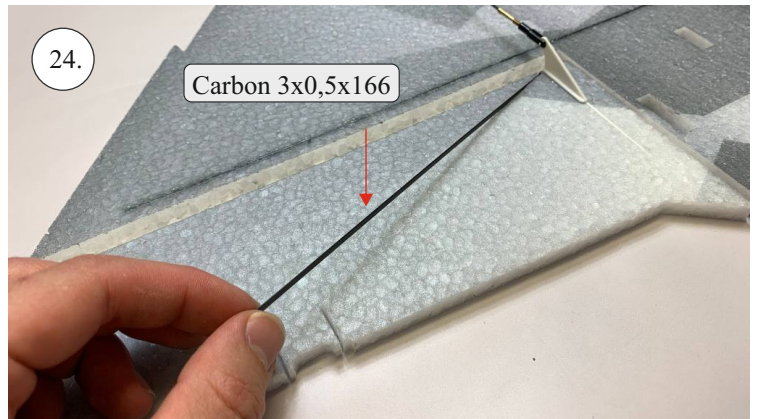
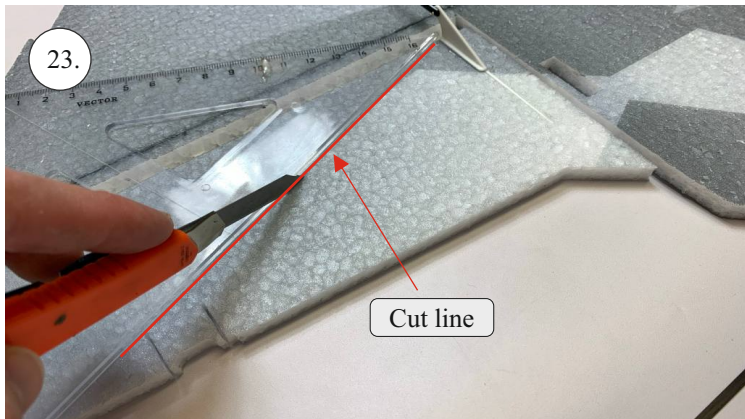

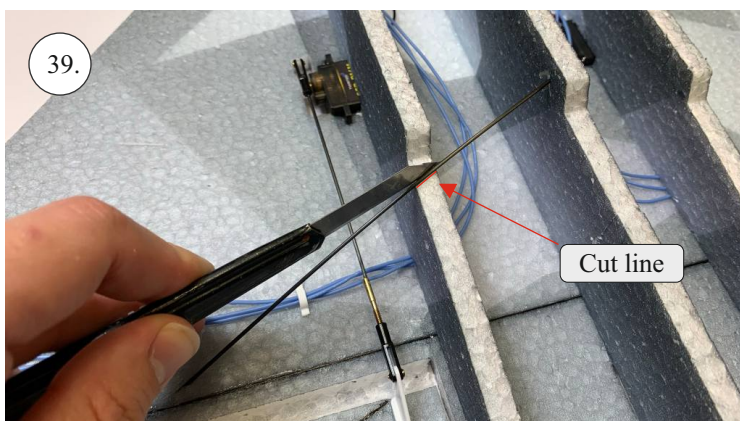
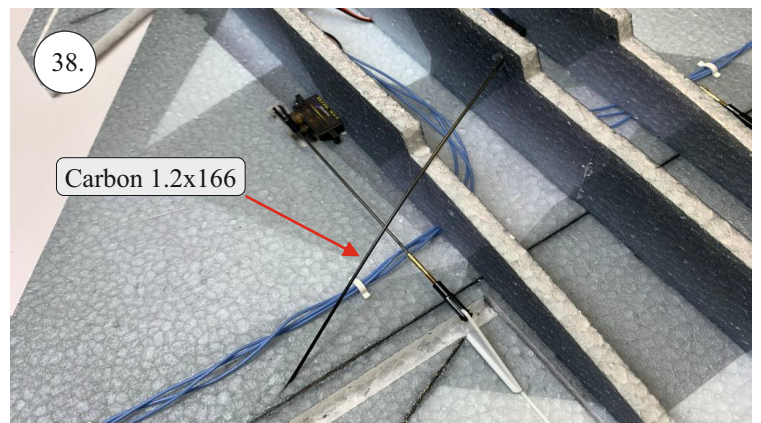
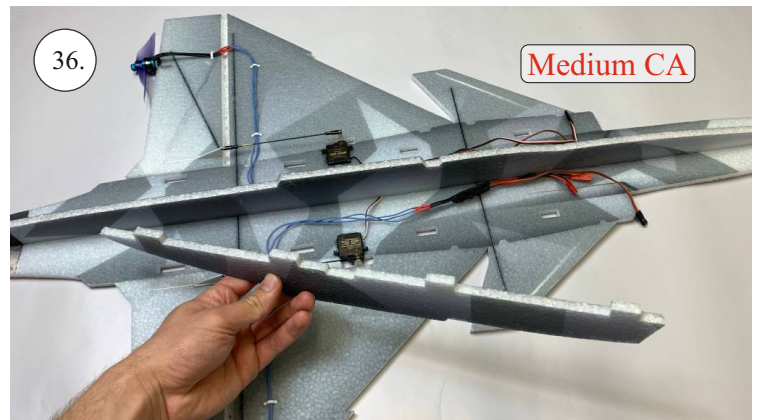
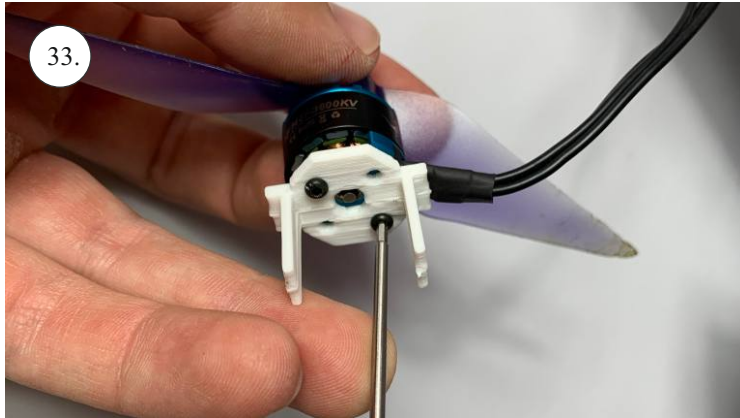
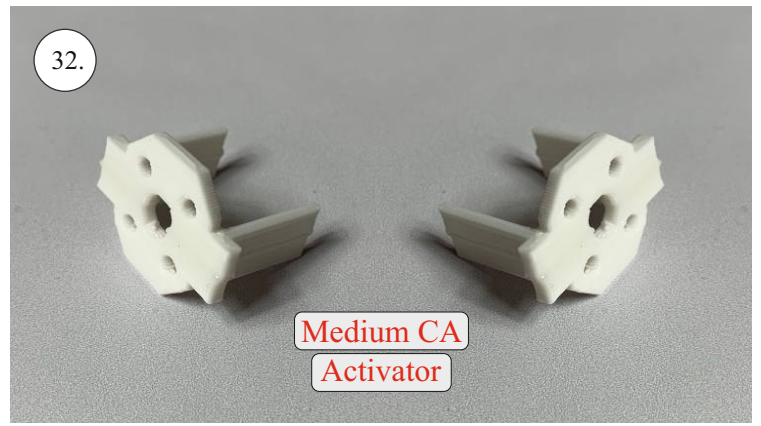
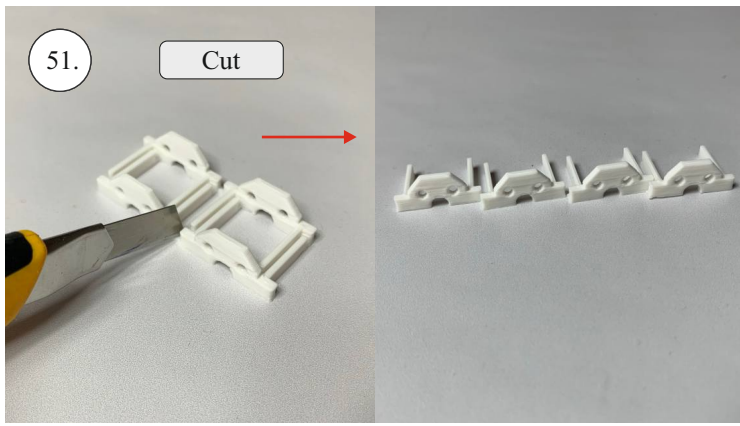

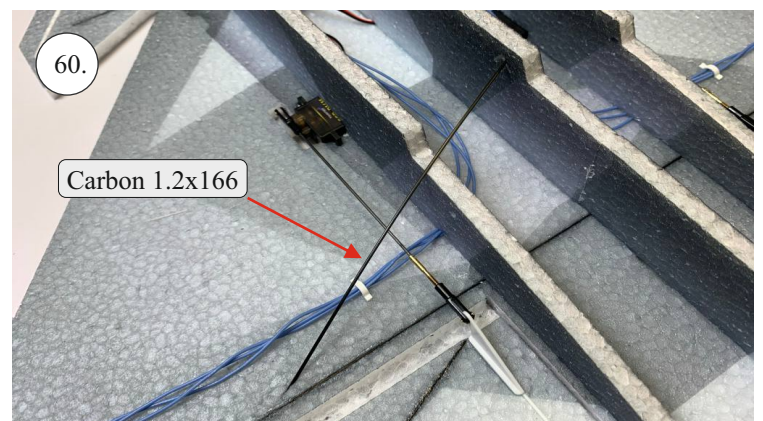
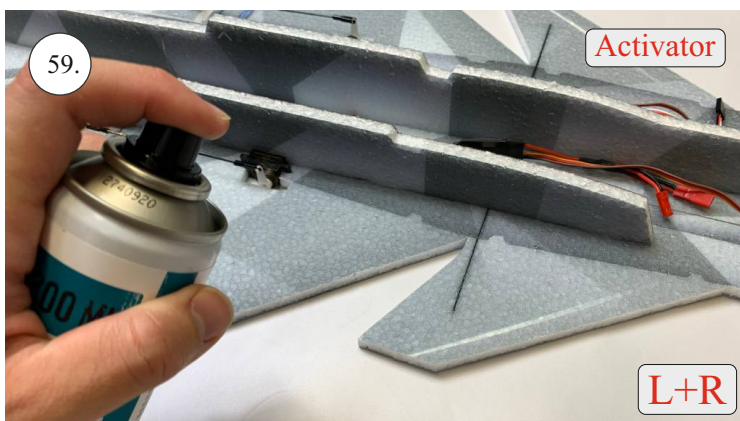
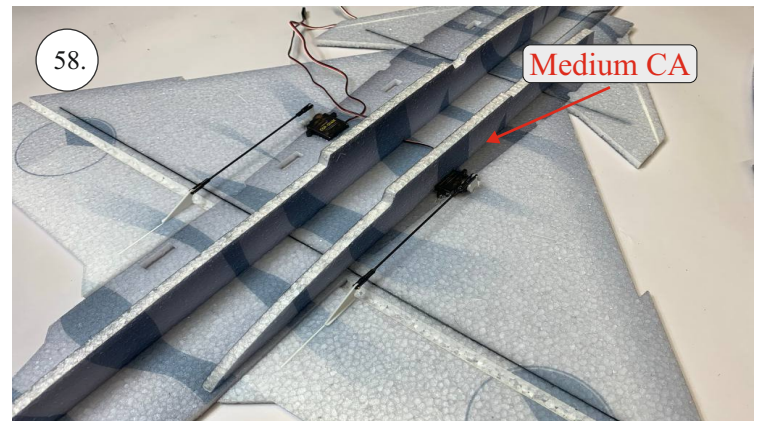
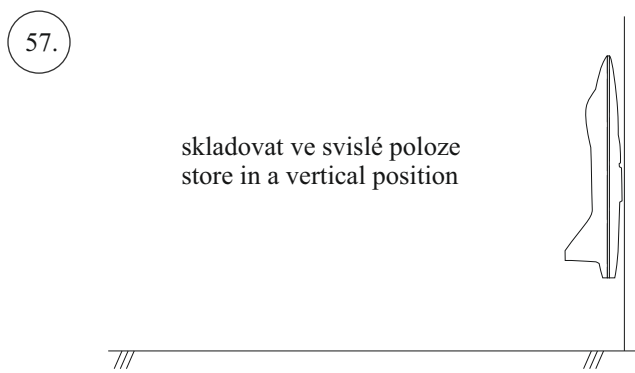
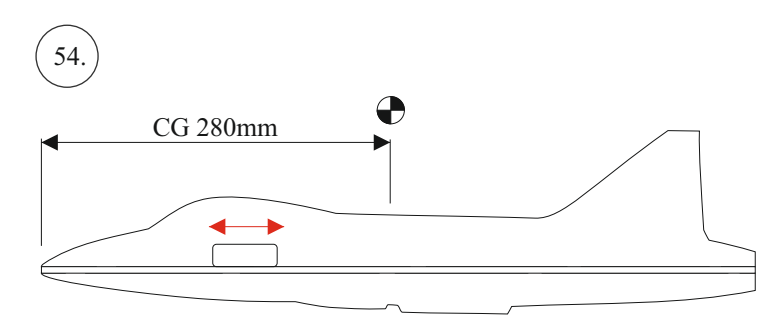
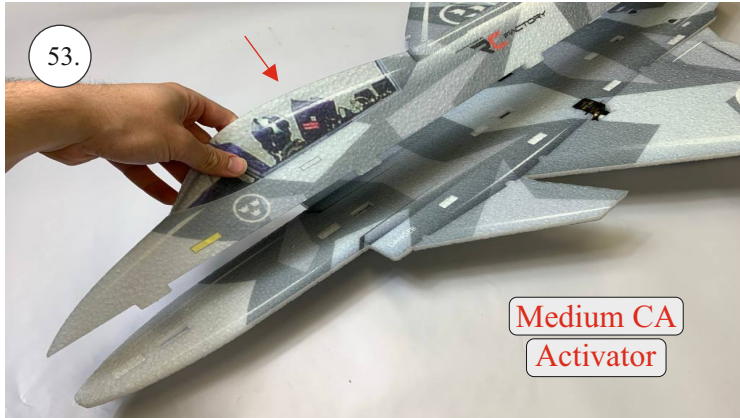
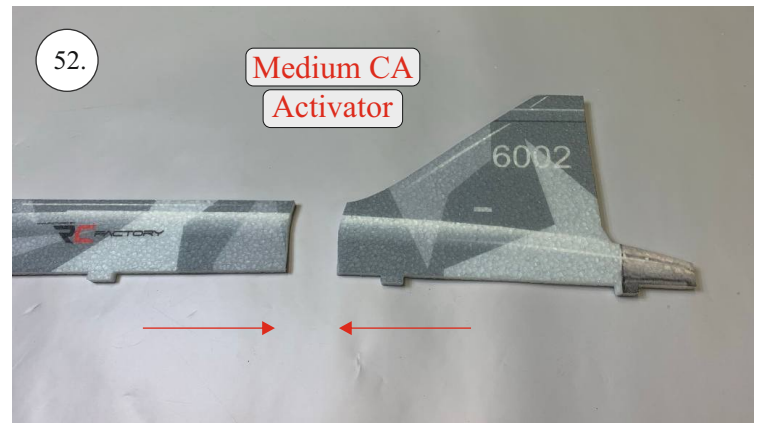
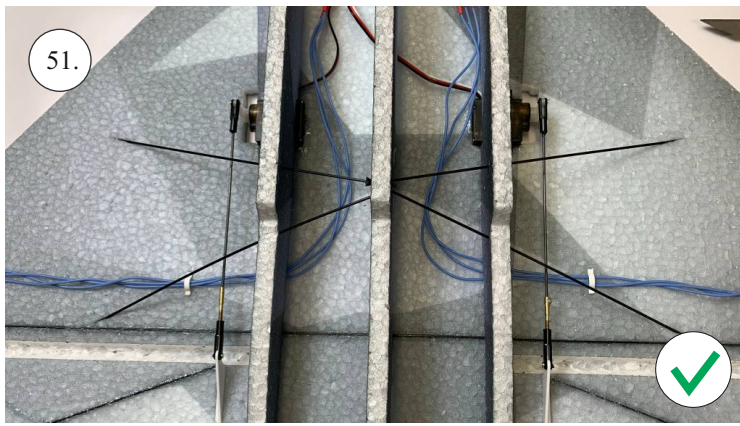

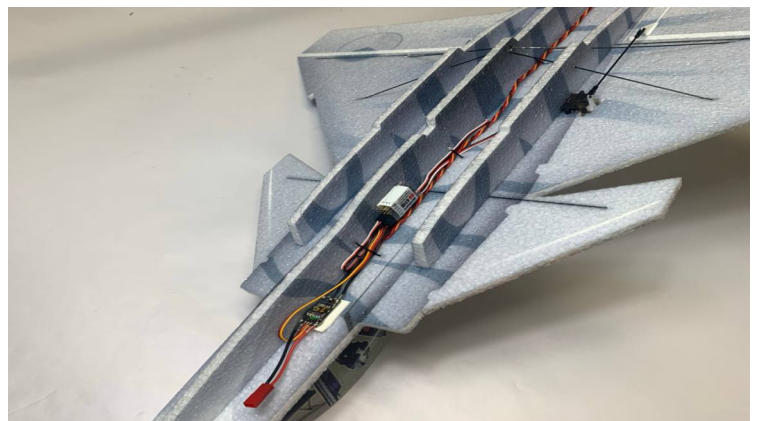
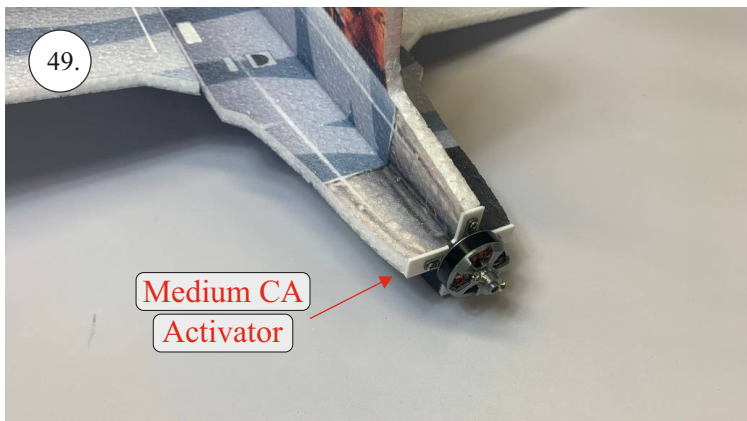
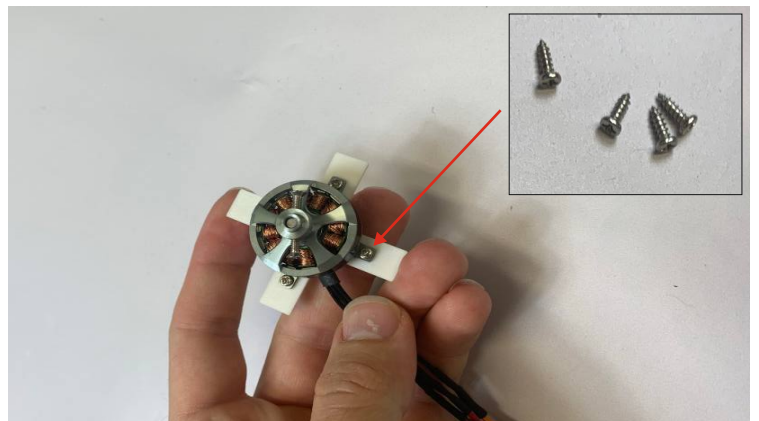
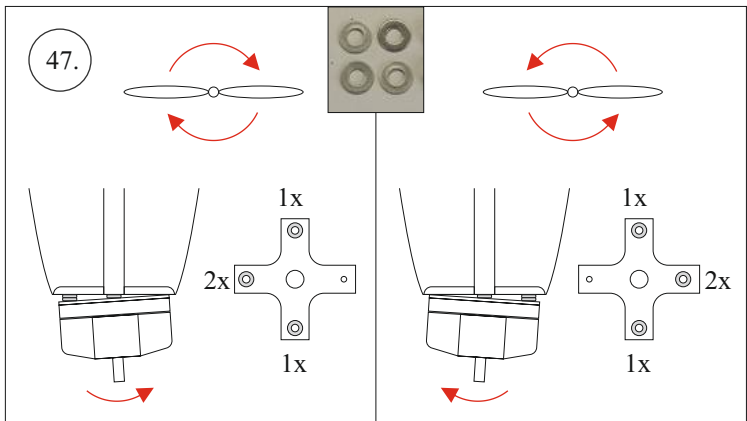
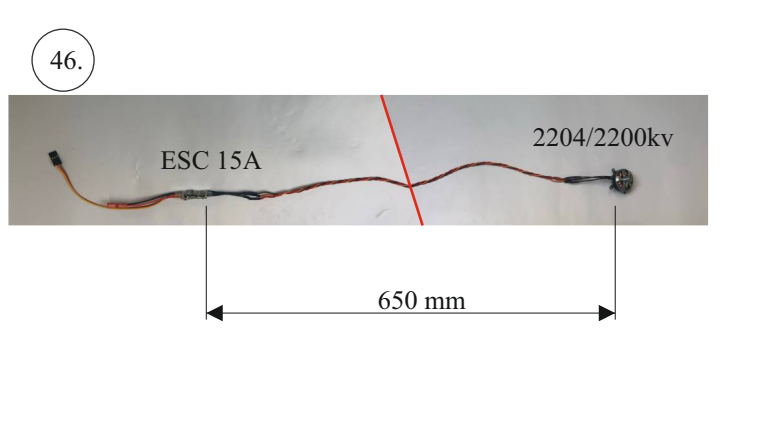
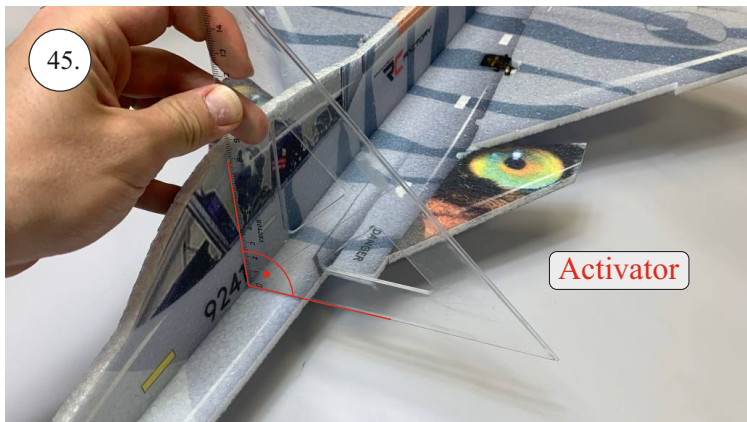
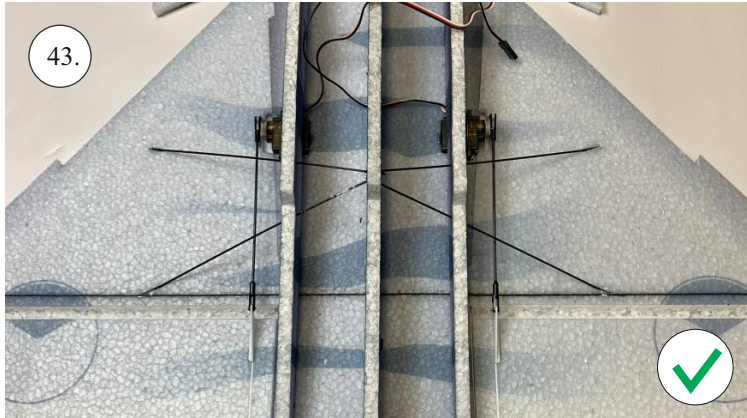
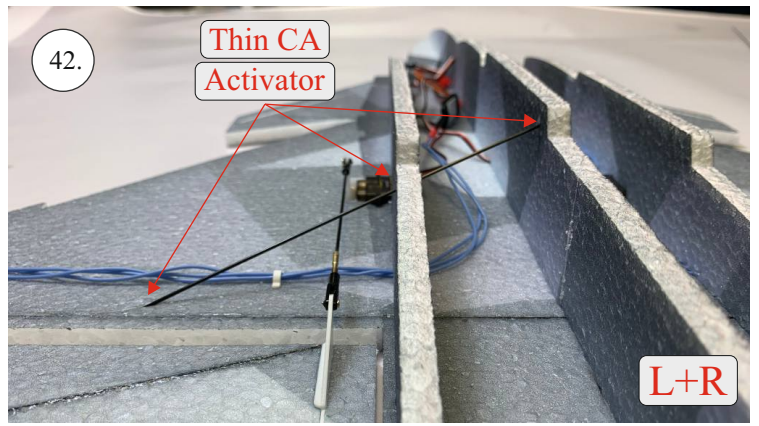
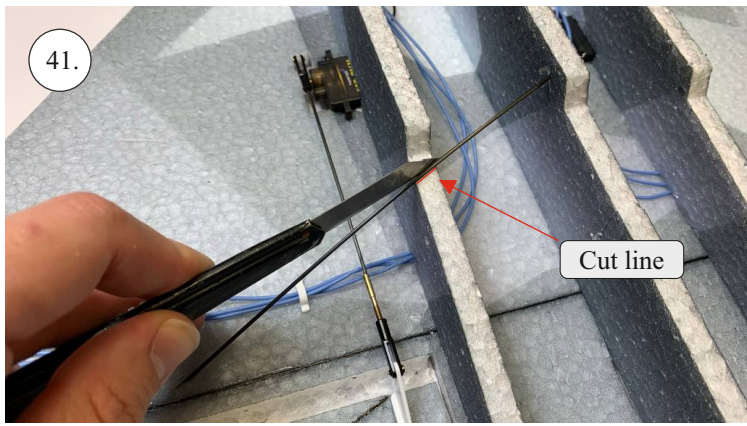

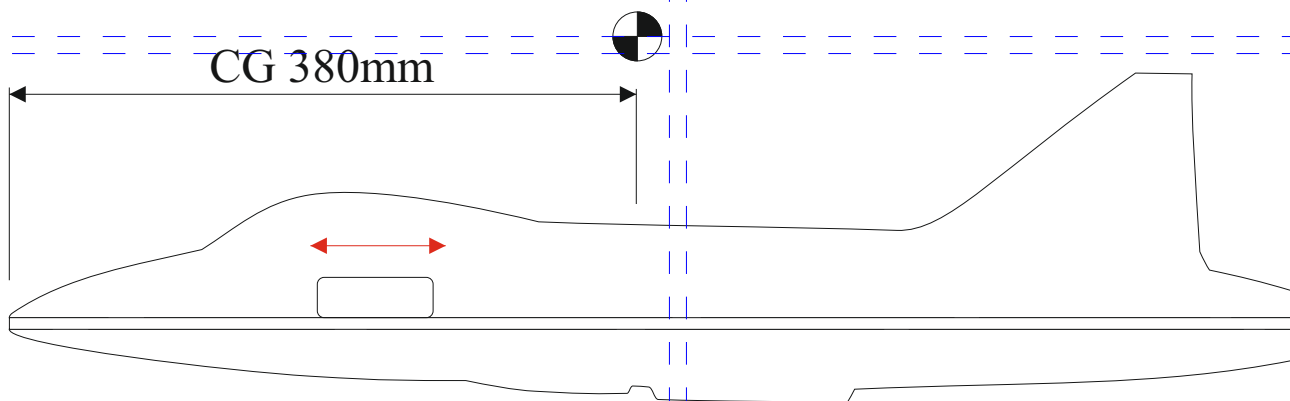

We wish you many happy flights.  
Přejeme mnoho zábavy.

RC Factory team