

CRACK PITTS XL

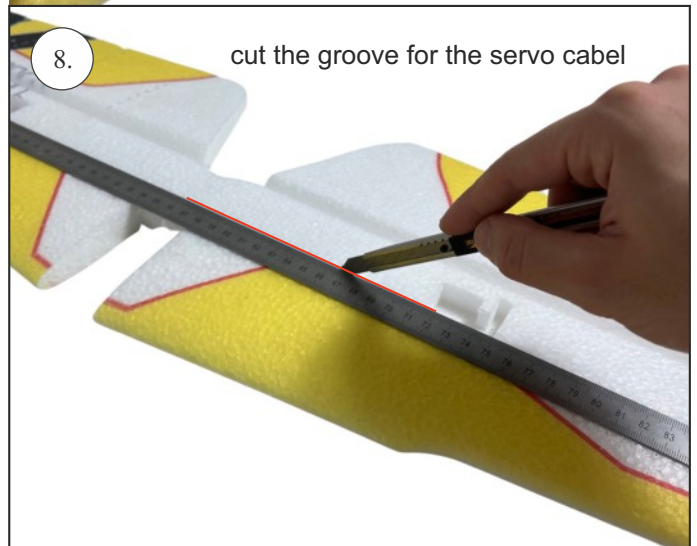

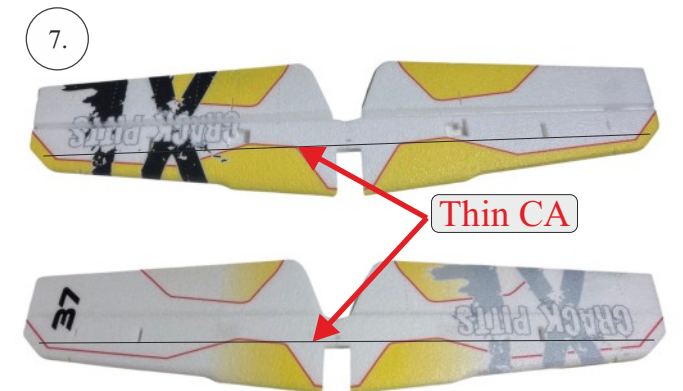

Do the same on the both wings

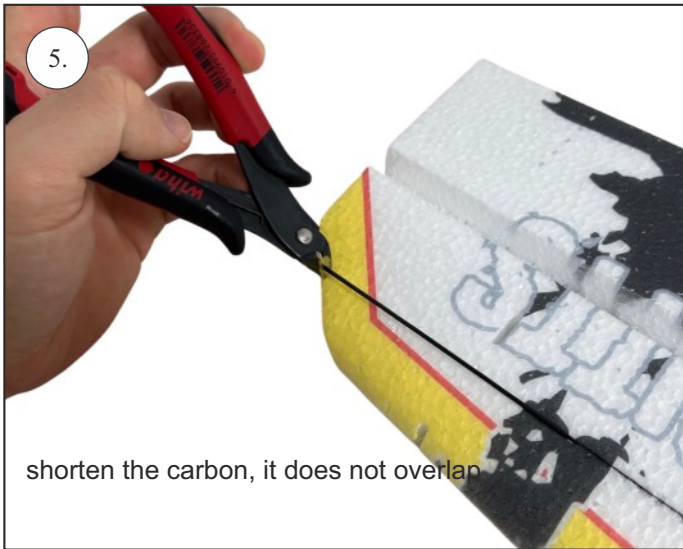
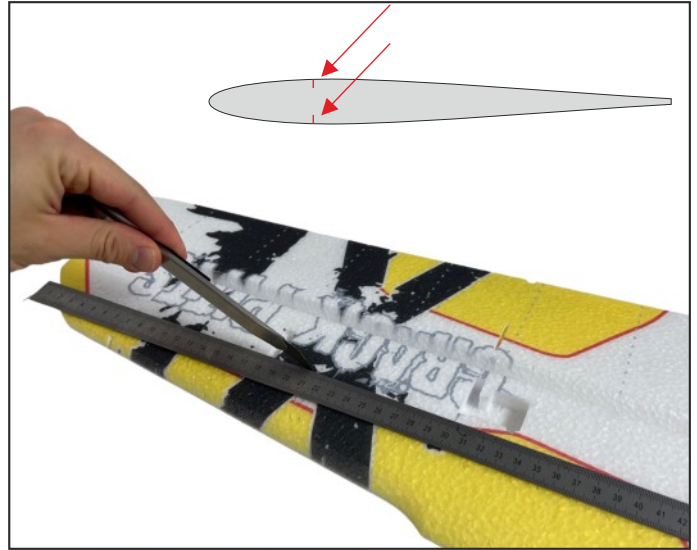
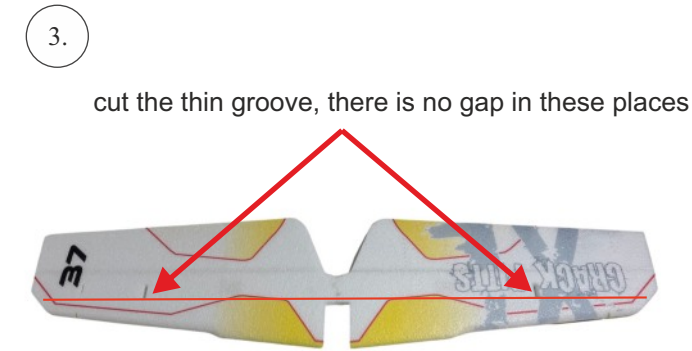
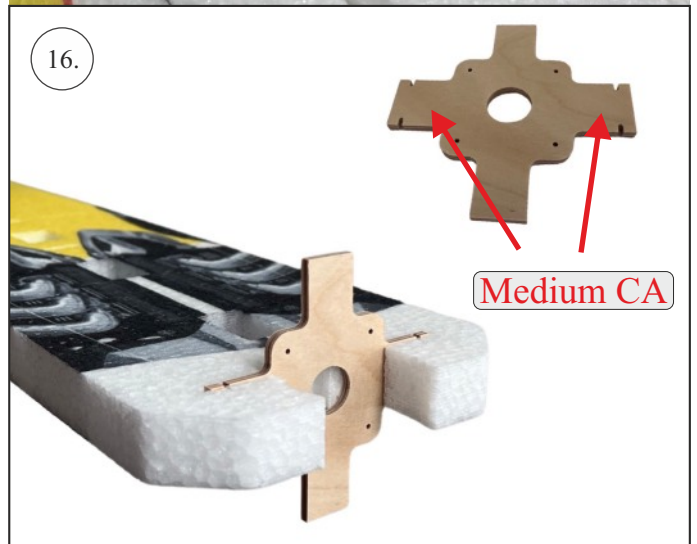
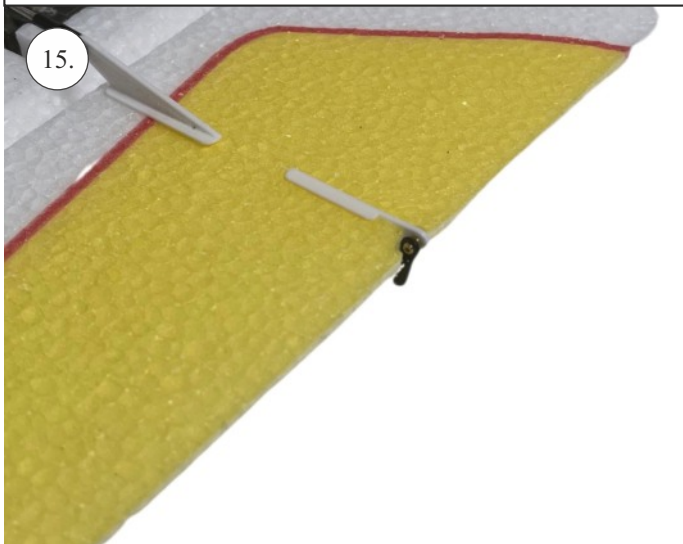
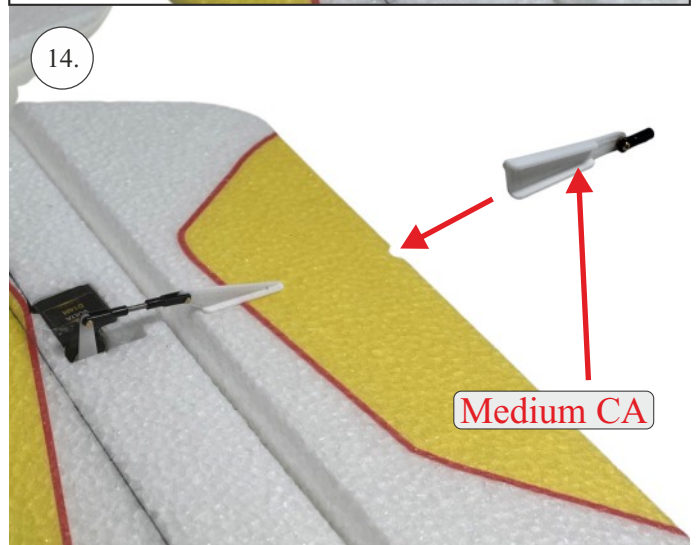
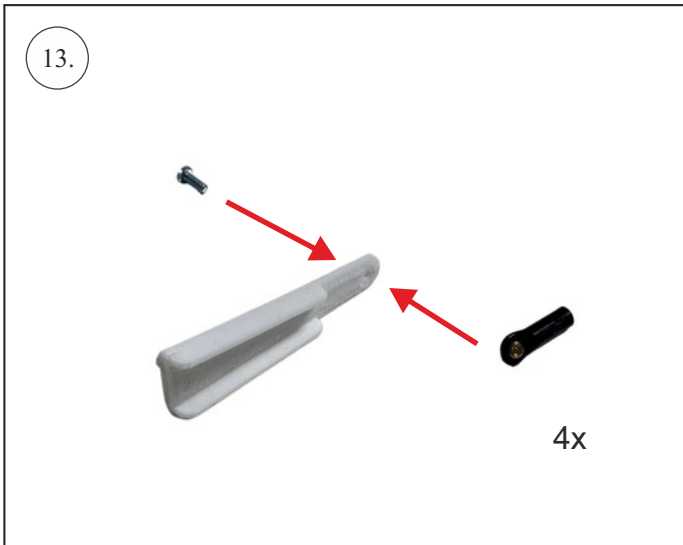
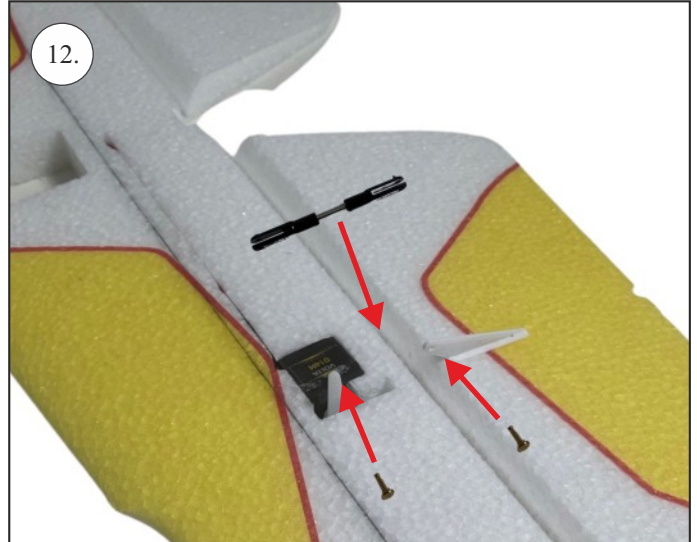
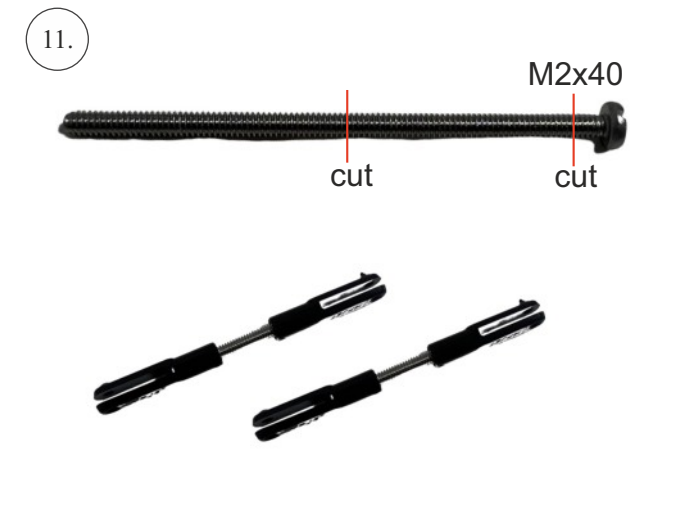

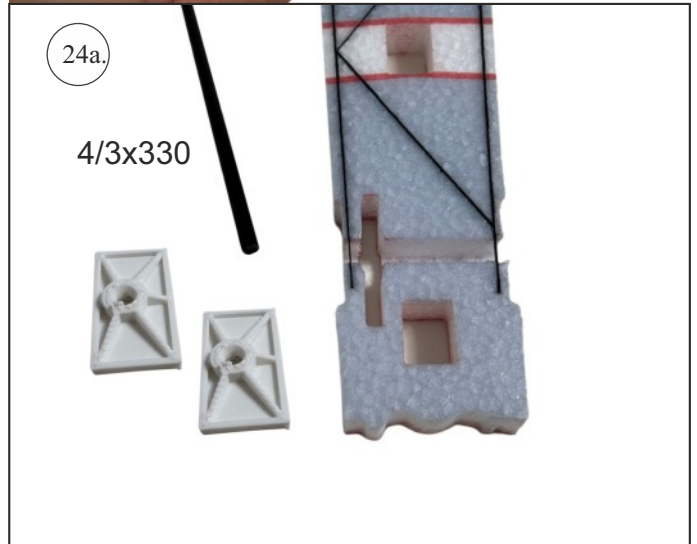
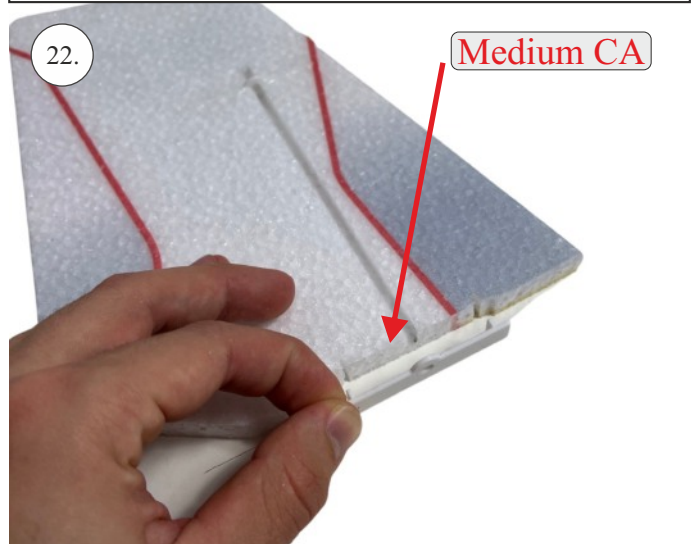
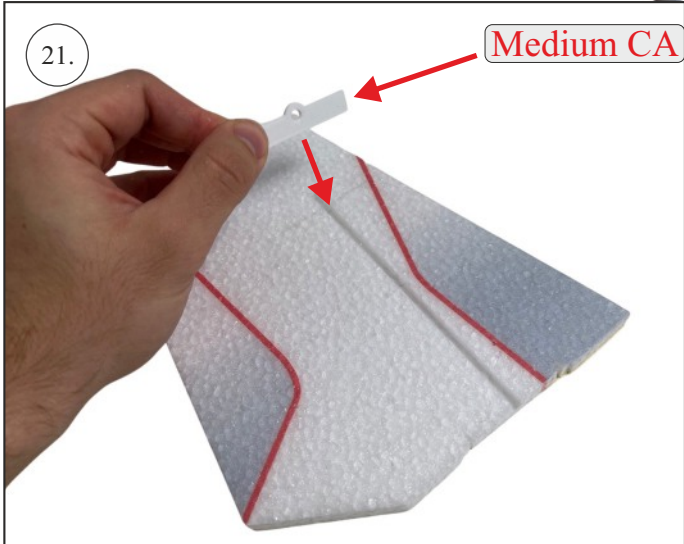
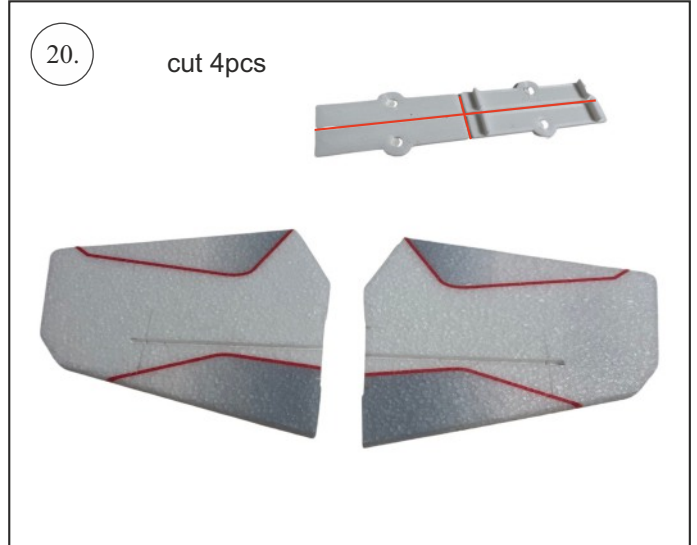
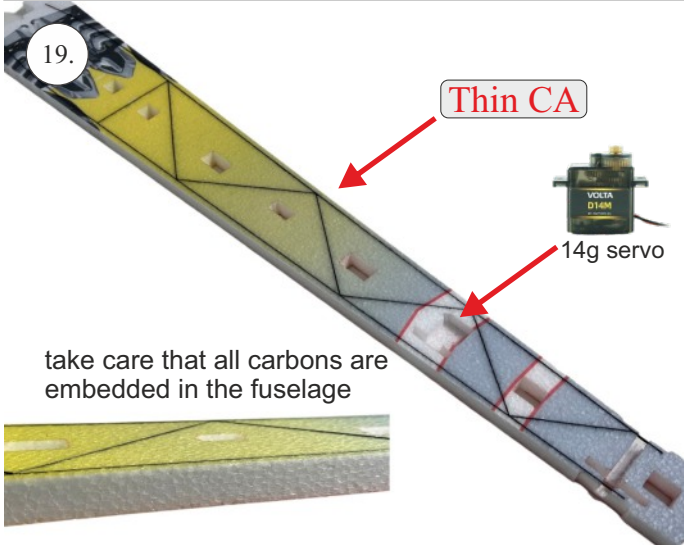
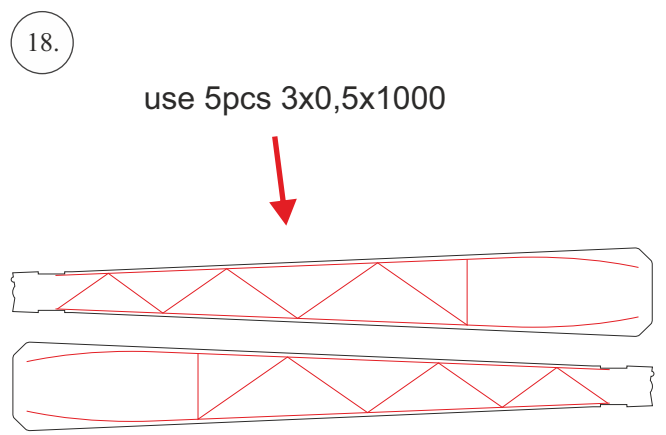
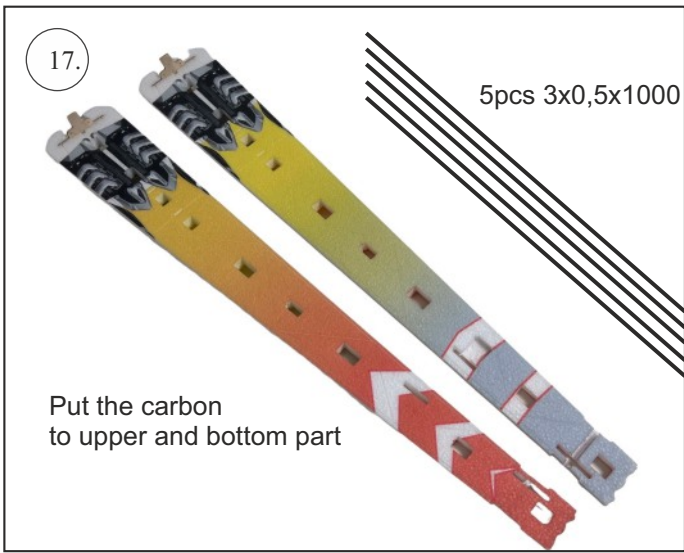

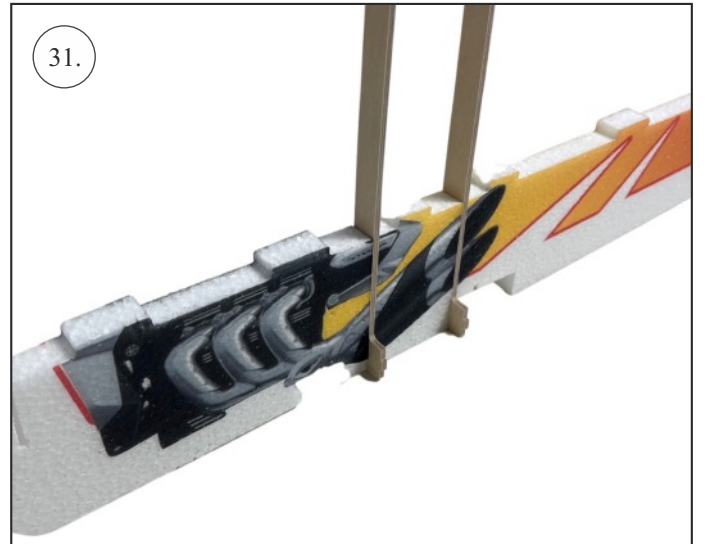
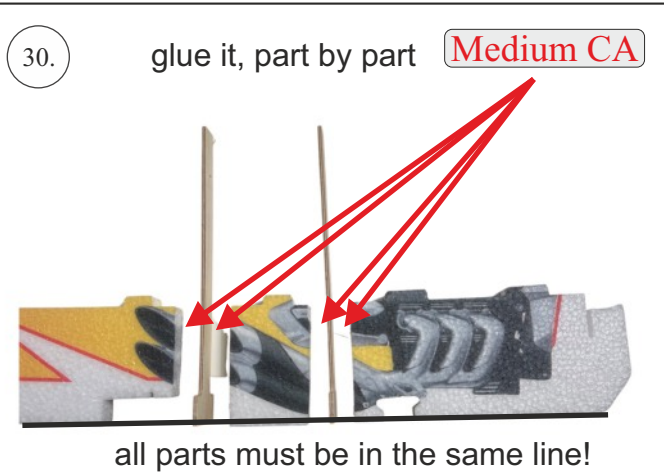
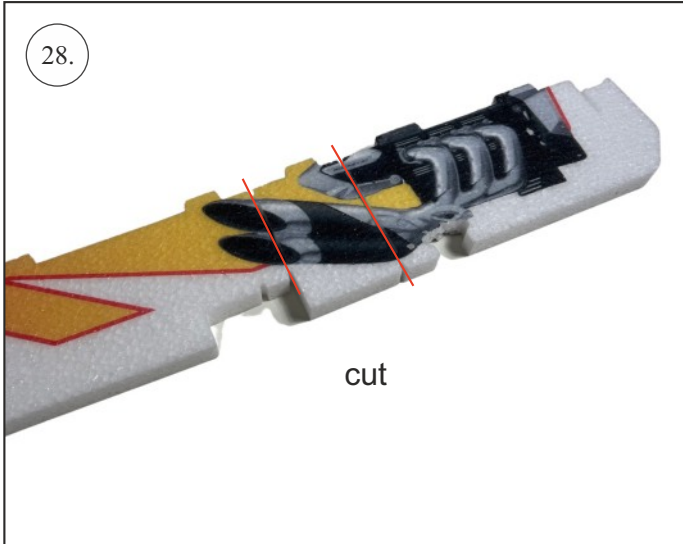
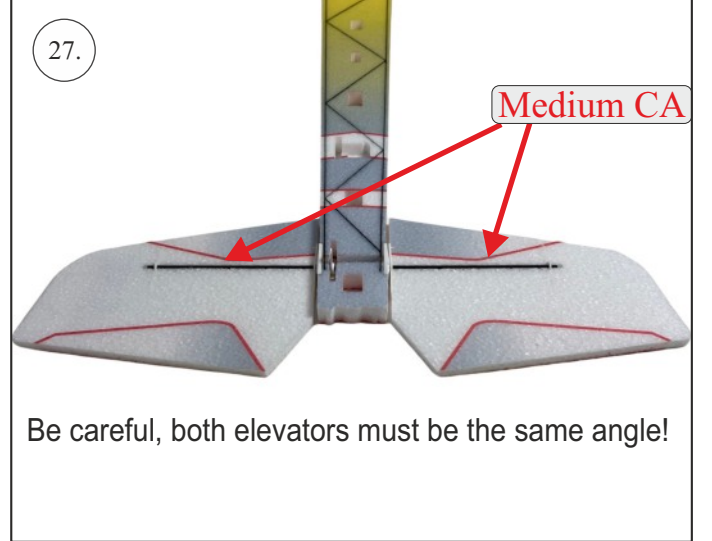
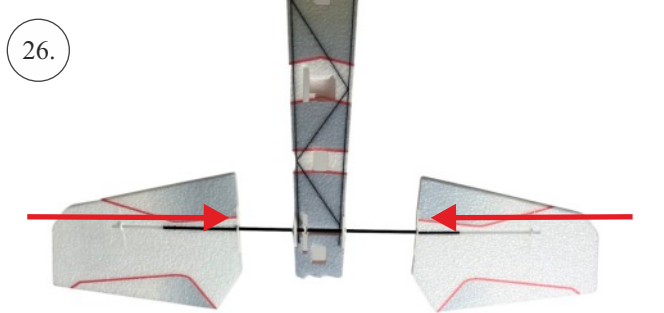
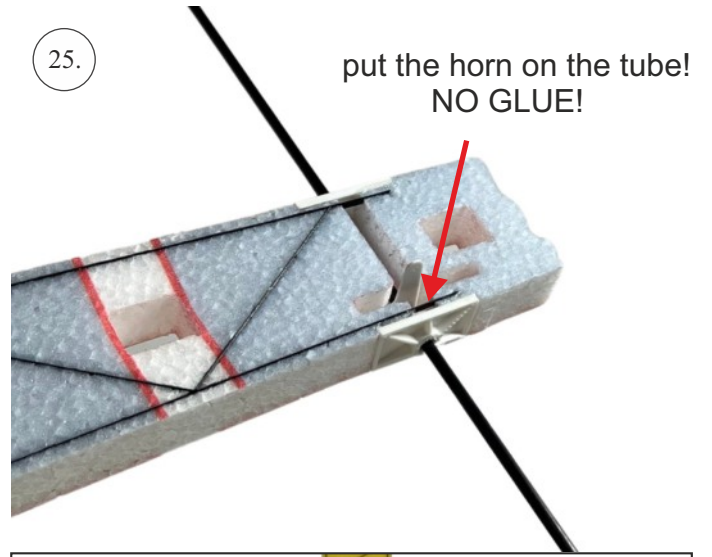
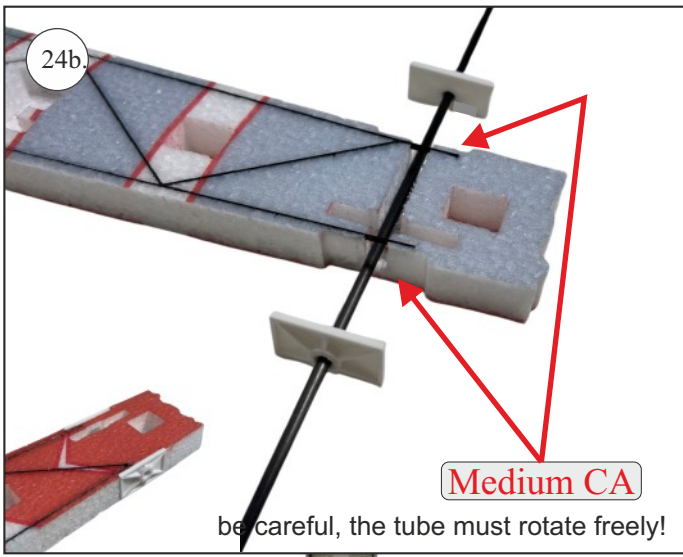

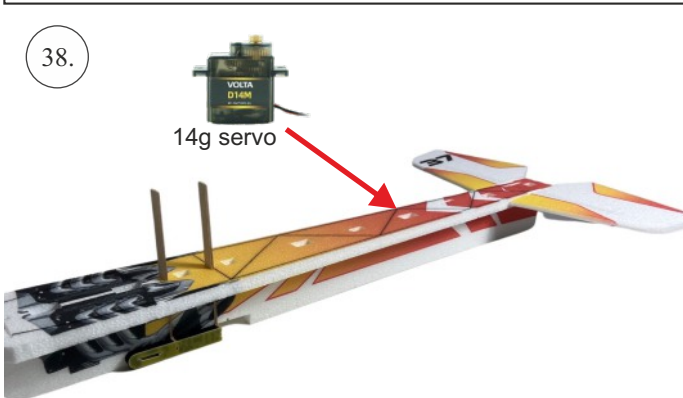
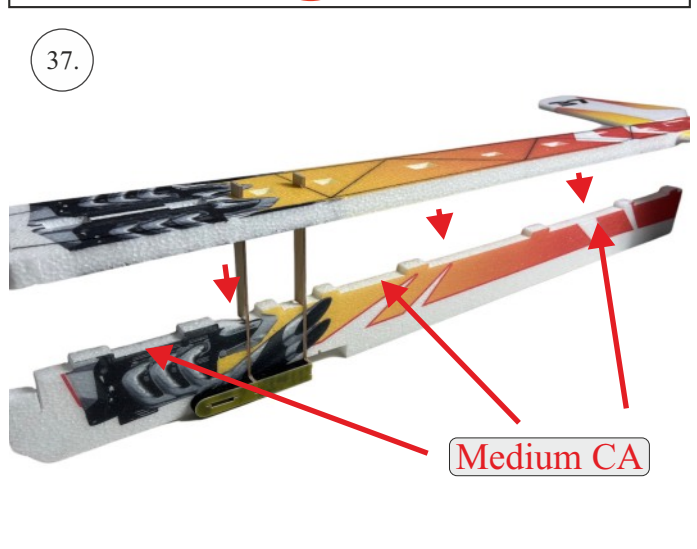
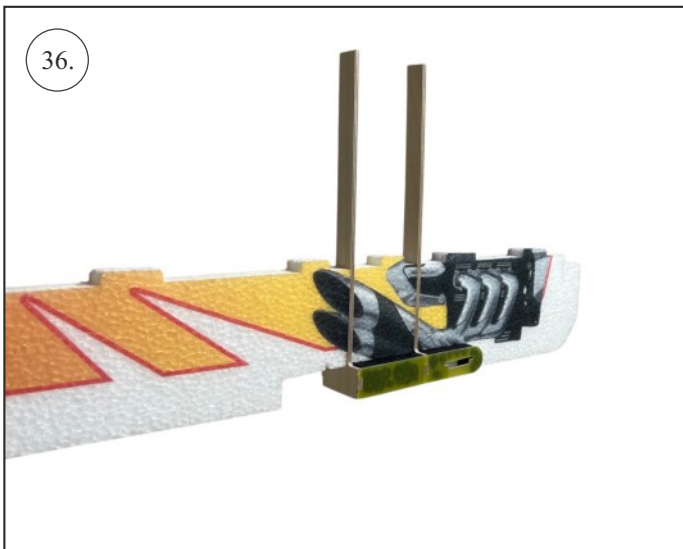
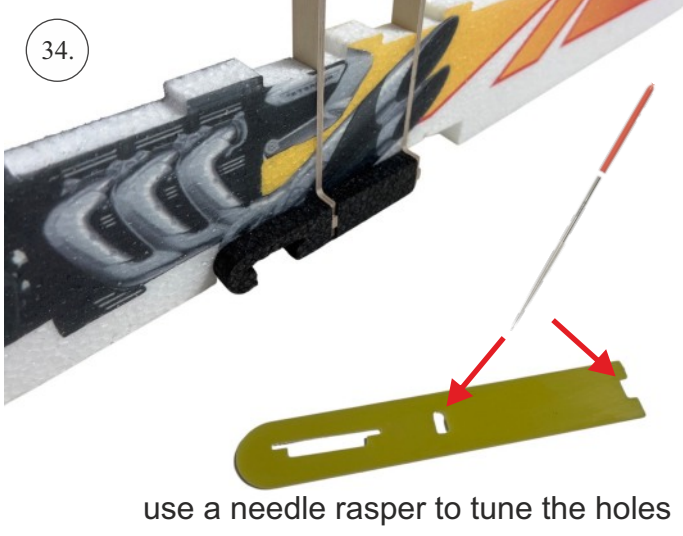
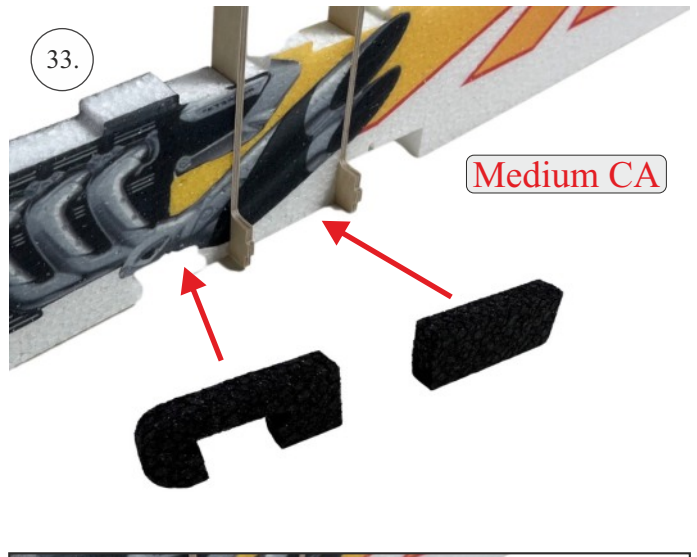
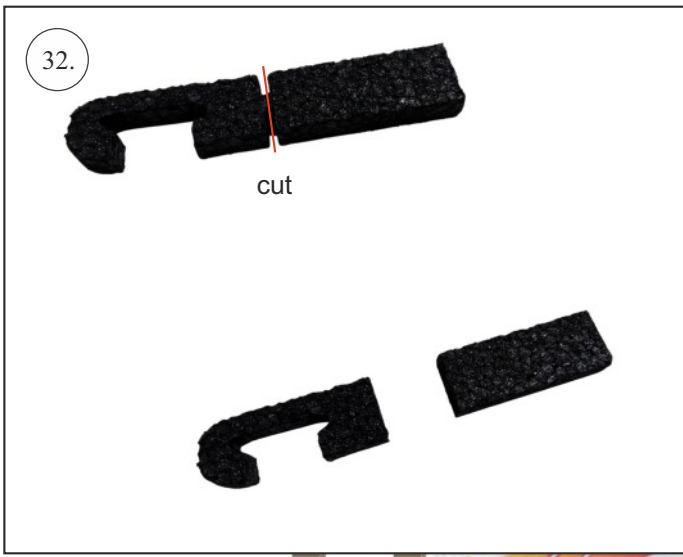

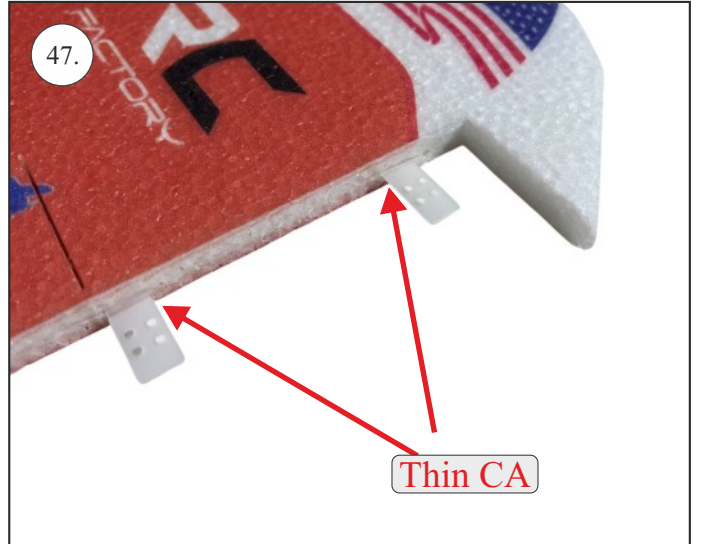
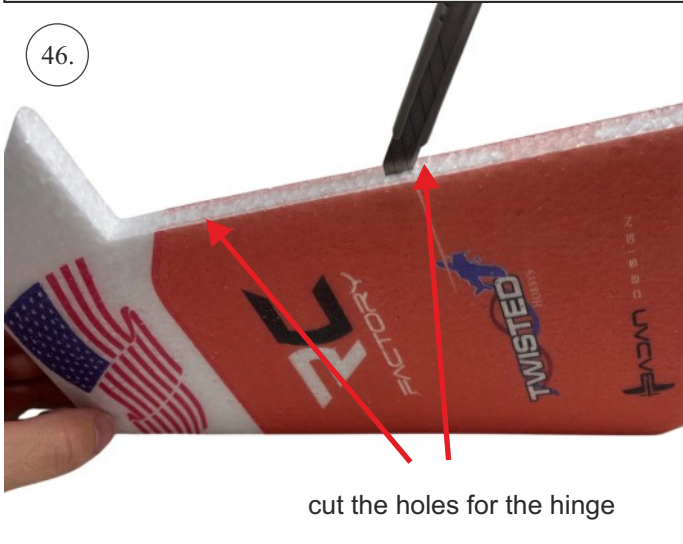
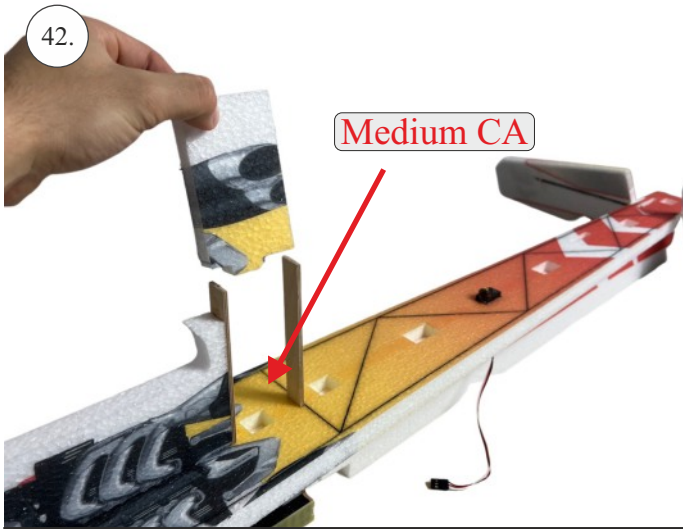
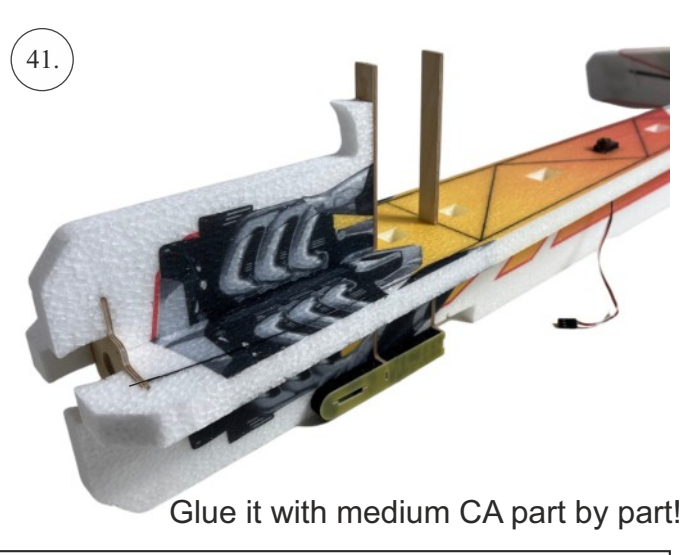
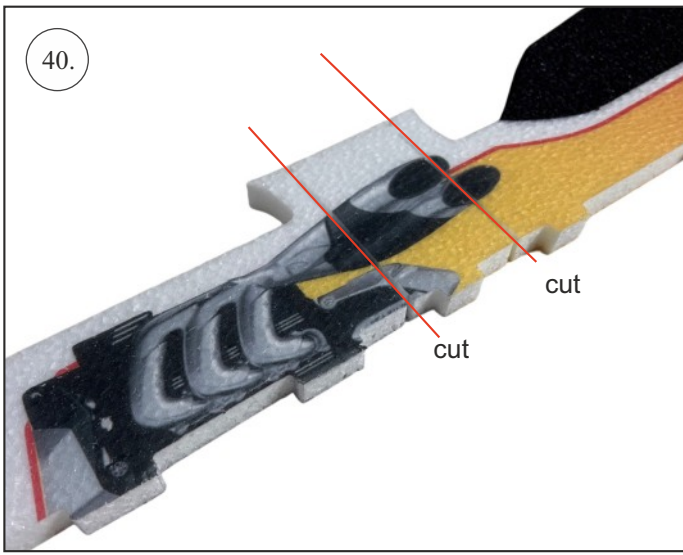

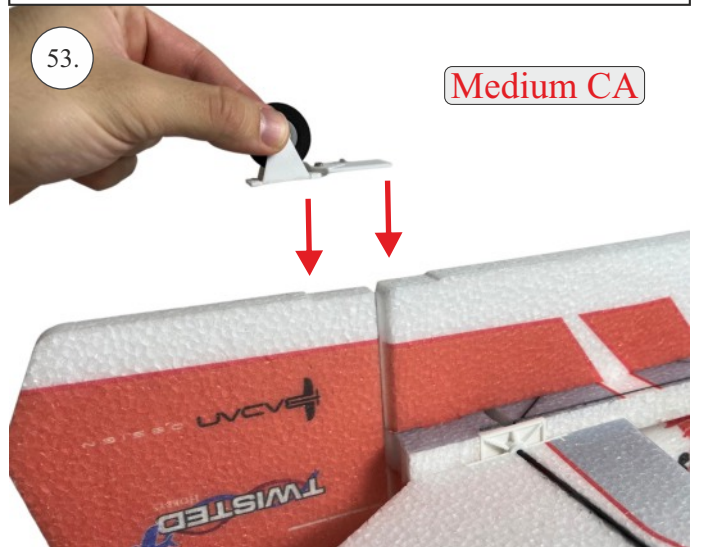
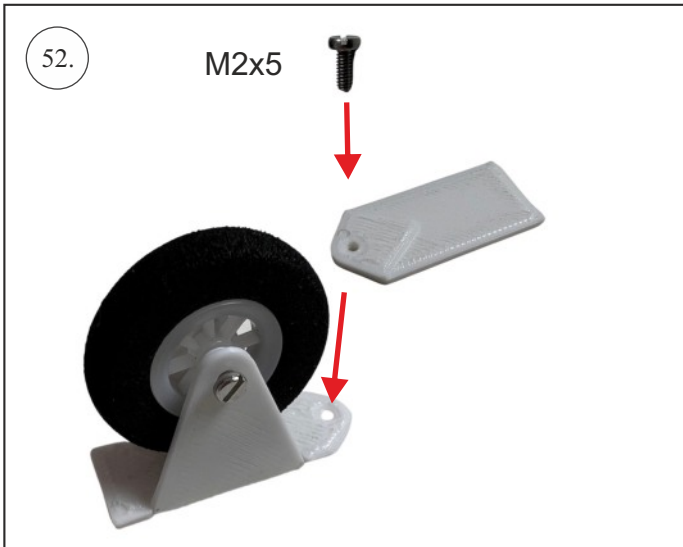
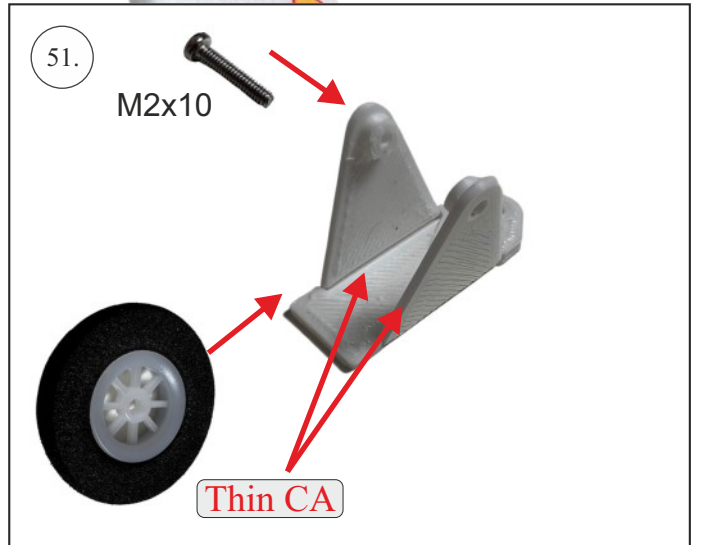
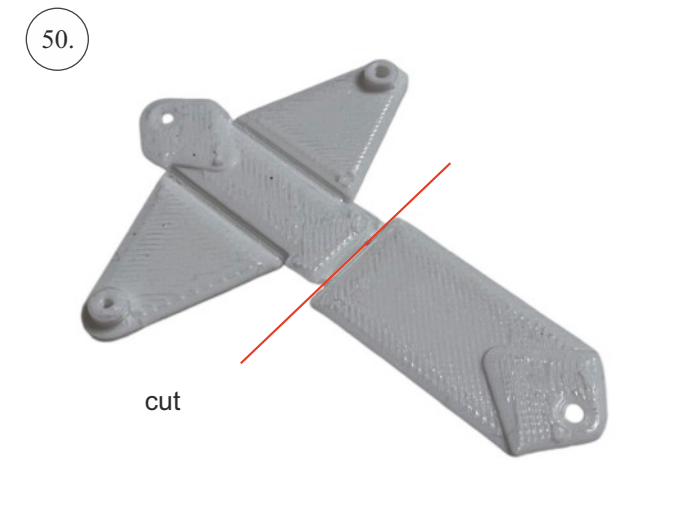
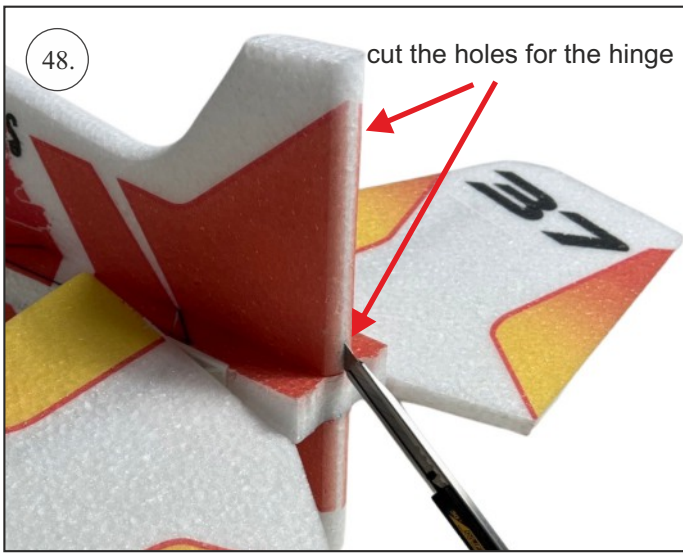

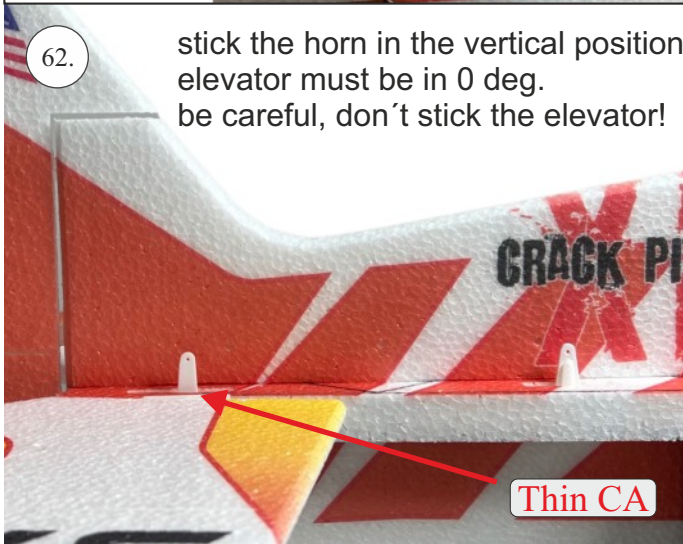
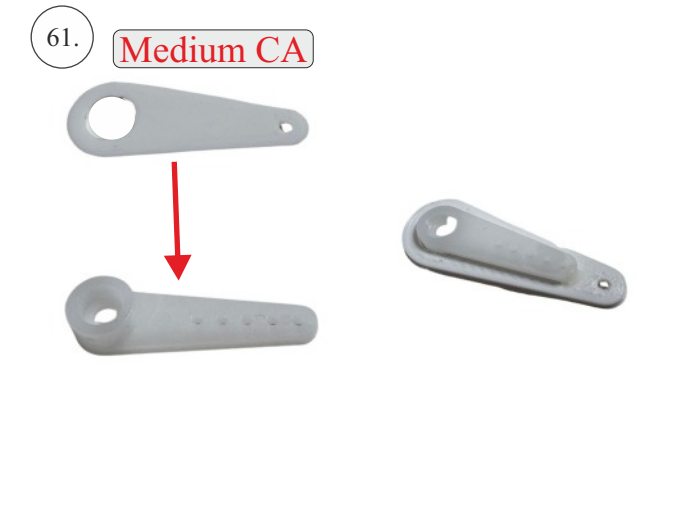
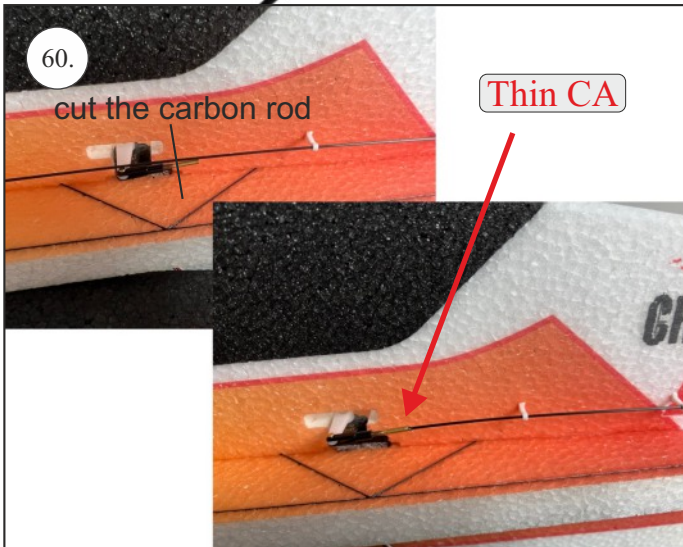
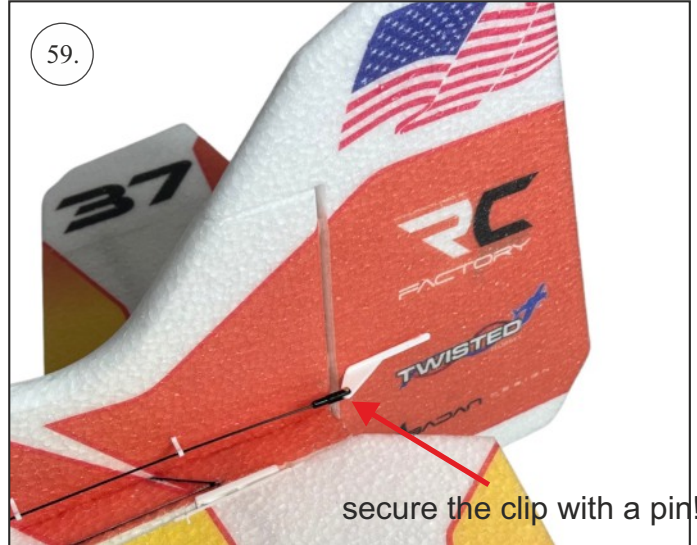
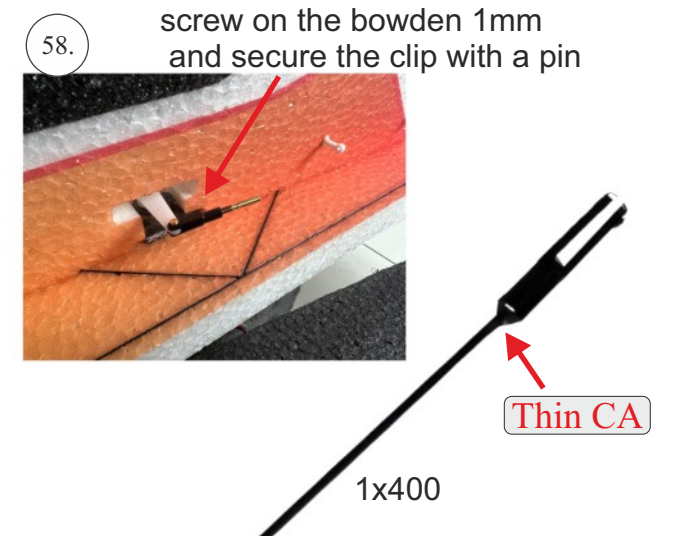
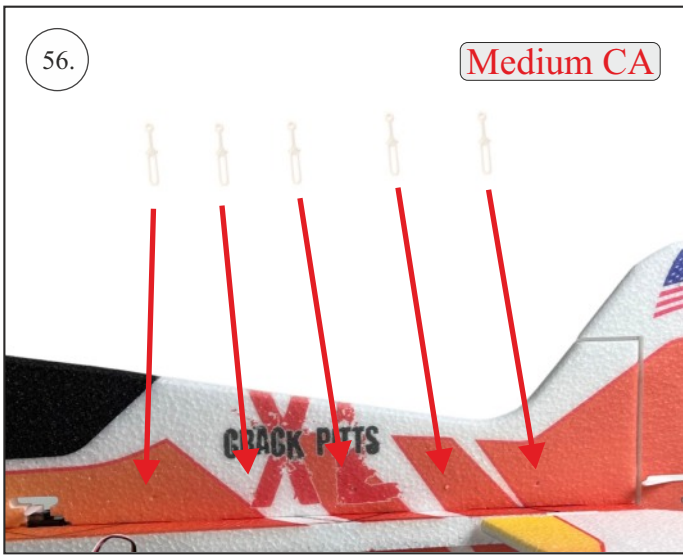

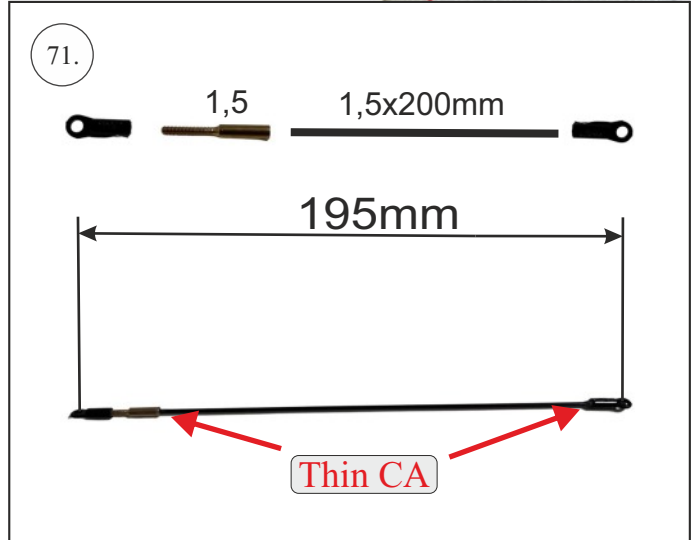
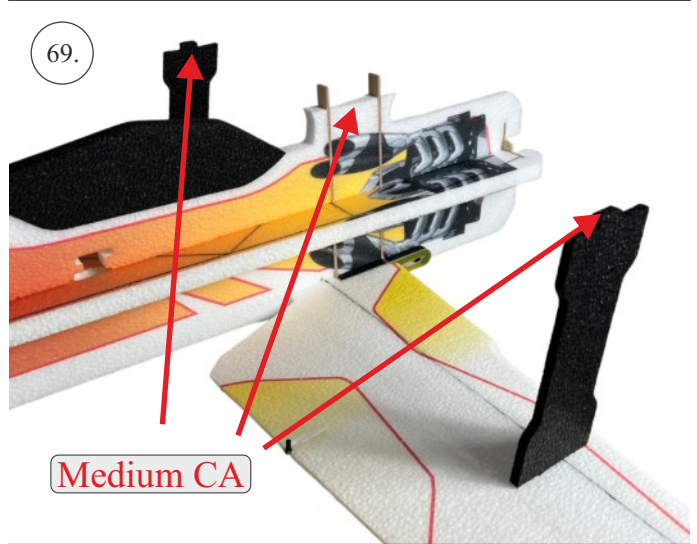
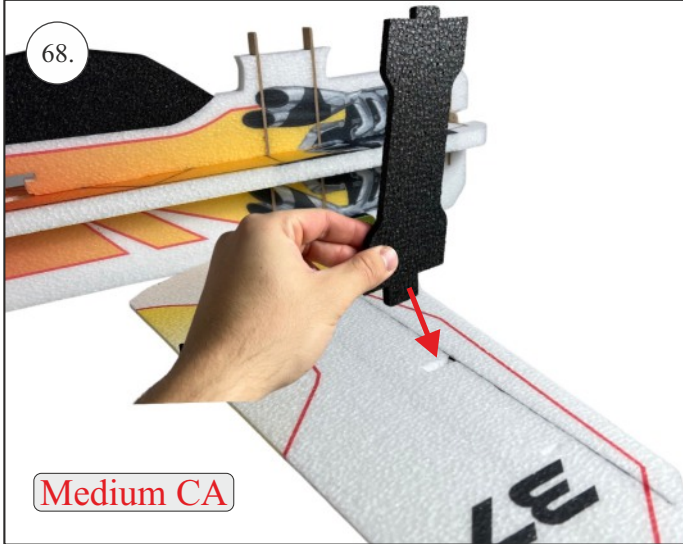
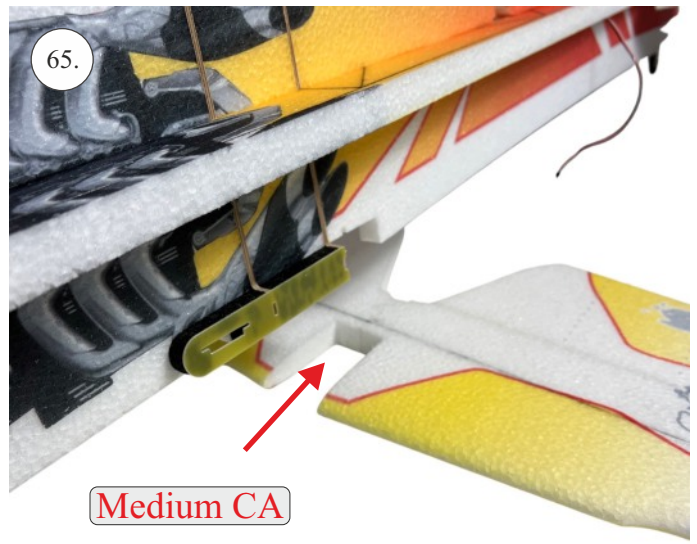
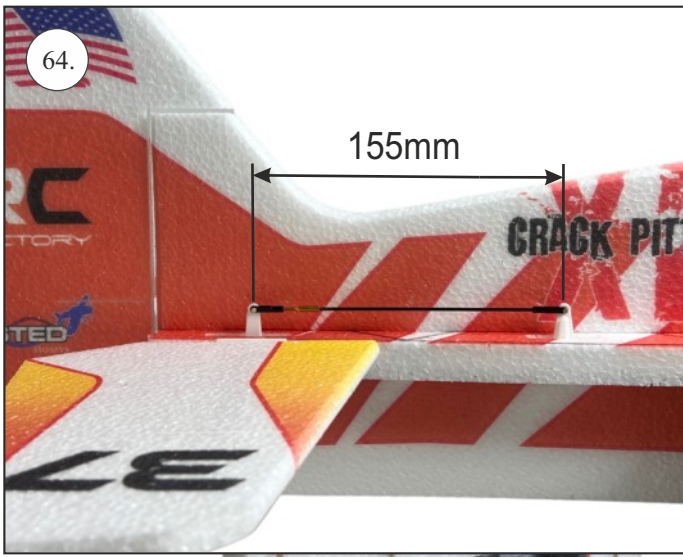

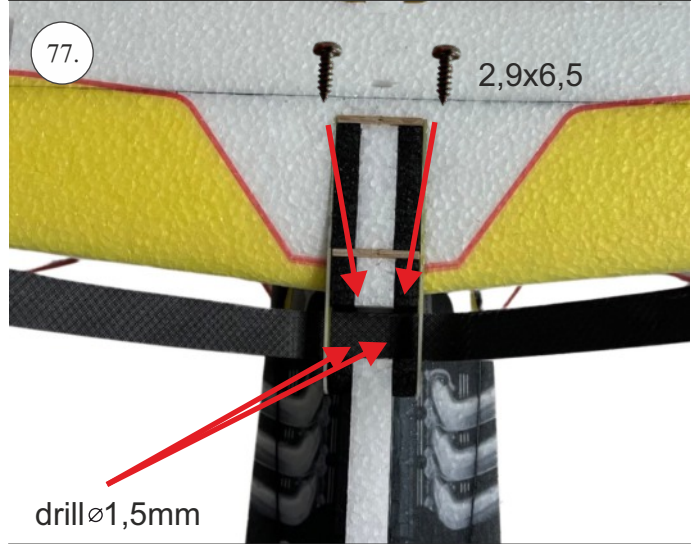
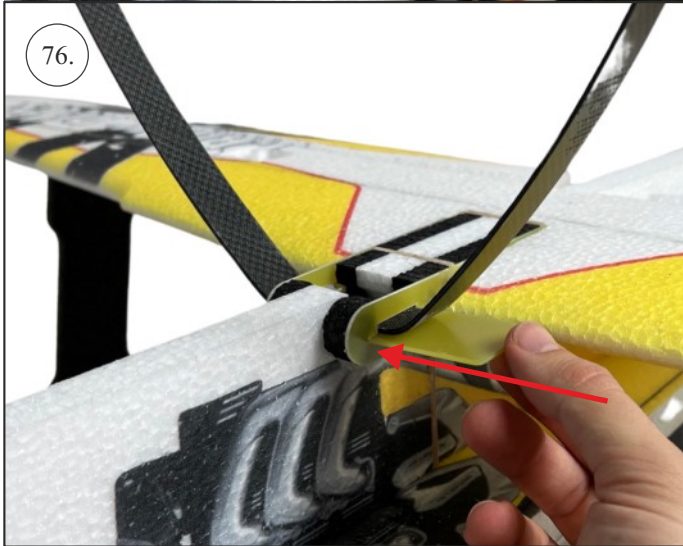
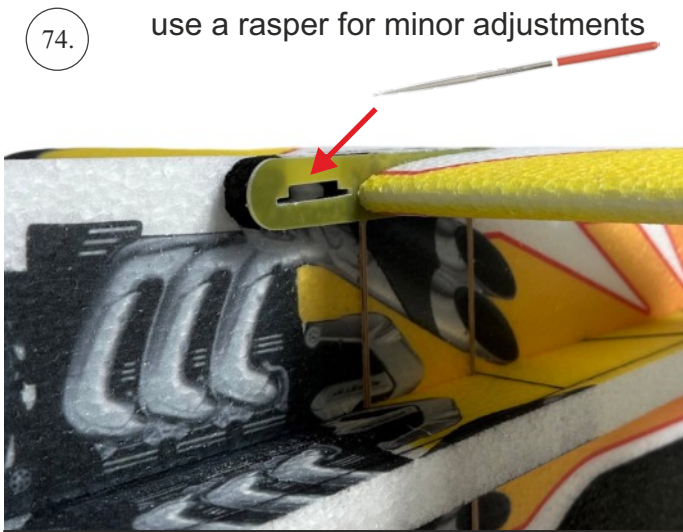
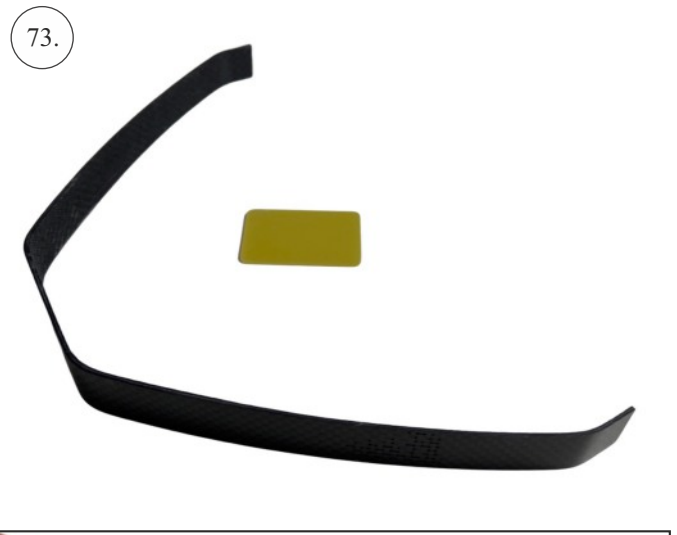
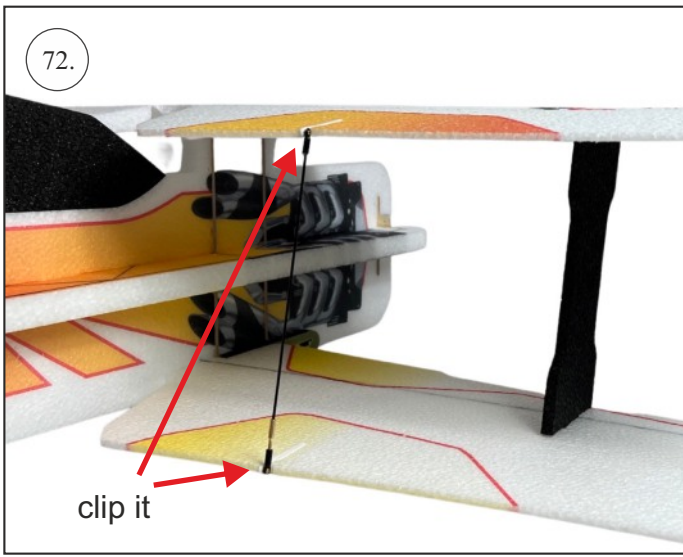

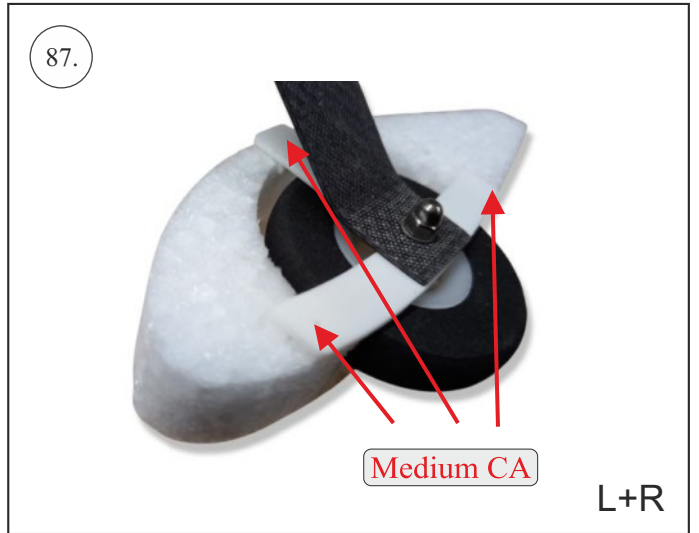
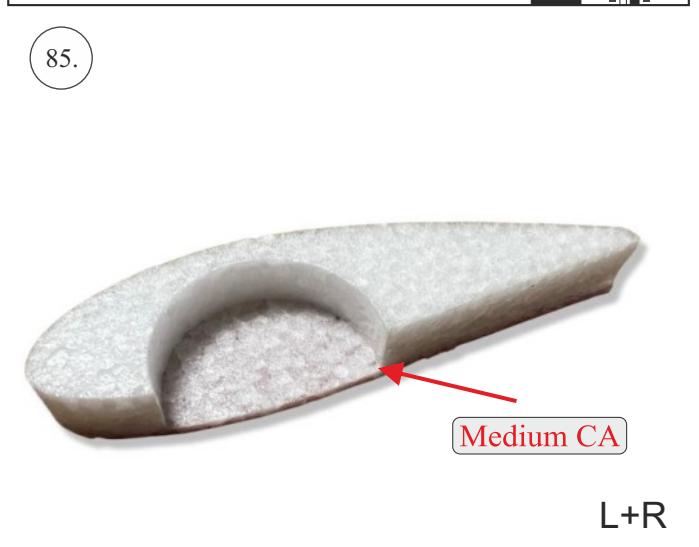
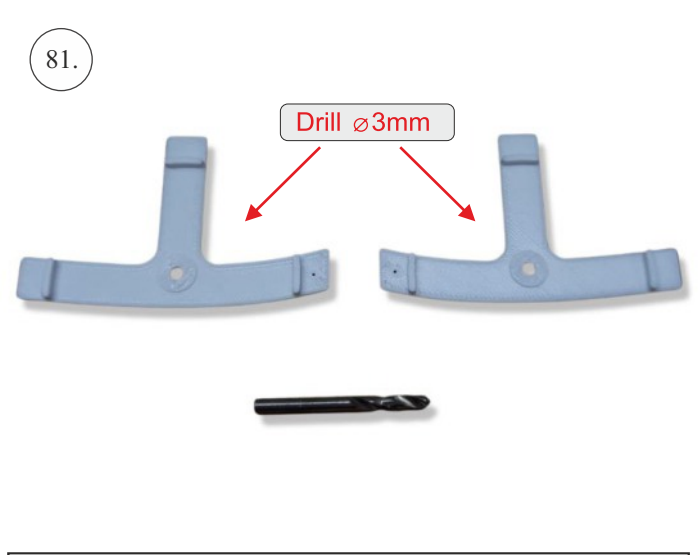
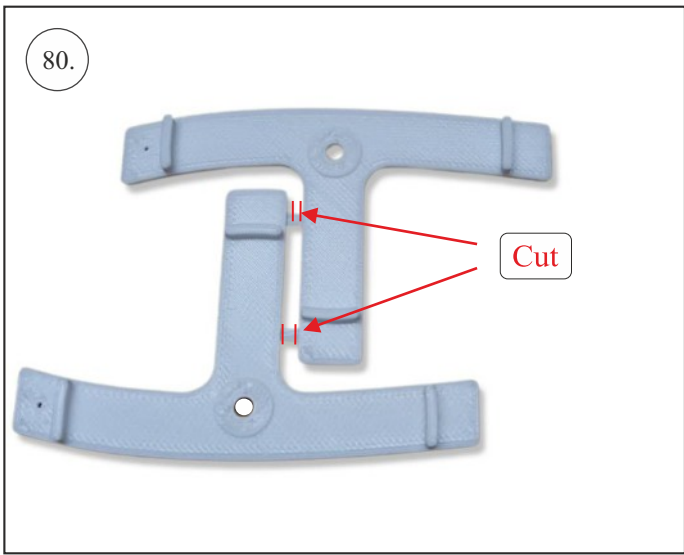

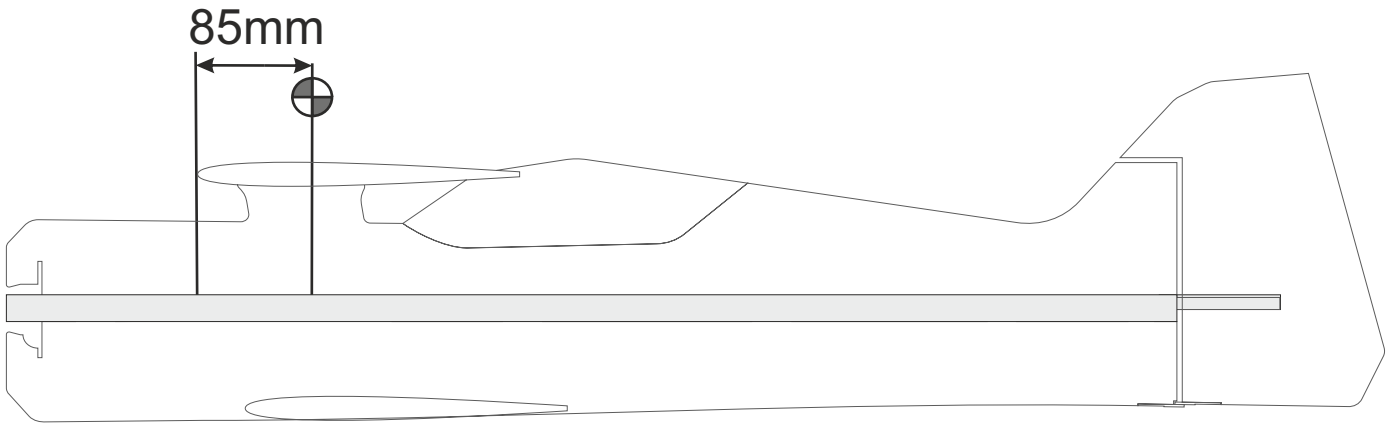

We wish you many happy flying hours with the Crack Pitts XL.

Your RC Factory team